



APPROVAL SHEET

Approval Specification	Customer's Approval Certificate
<p>TO:</p> <p>Part No.:</p> <p>Customer's Part No.:</p>	<p>Please return this copy as a certification of your approval</p> <p>Checked & Approved by:</p> <p>Date:</p>

BEIJING ZHONGXUN SIFANG SCIENCE & TECHNOLOGY CO.,LTD.

Tel: +86-010-62968745
 Fax: +86-010-62973654
 E-mail: bjzxsf@bjzxsf.net
 Website: <http://www.bjzxsf.net>
 Add: NO.7 NieGeZhuang Rd,SuJiaTuo Town,
 HaiDian District,Beijing,P.R.China



Part No.	:	SF4159
Pages	:	6
Date	:	2013/2/25
Revision	:	1.0

Prepared by:	
Checked by:	
Approved by:	

Application

- Low-loss SAW component
- Low amplitude ripple
- Sharp rejections at both out-bands
- Usable passband 5MHz

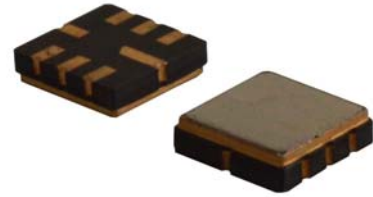

Features

- Ceramic Package for **Surface Mounted Technology (SMT)**
- **RoHS** compatible
- Package size 5.00x5.00x1.50mm³
- Package Code QCC8C
- **Electrostatic Sensitive Device(ESD)**

Package Dimensions (Unit: mm)

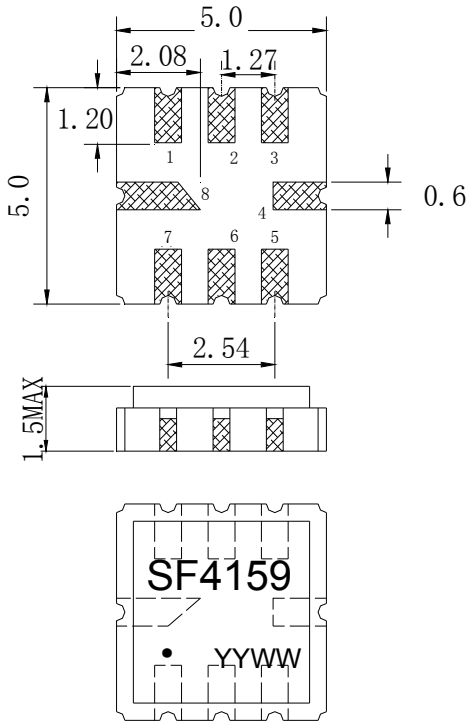

Pin Configuration

Pin No.	Description
2	Input
6	Output
1,3,4,5,7,8	Ground

Marking Description

S	Trademark
F	SAW Filter
4159	Part Number
●	Pin 1
YYWW	Year Code & Week Code

*Fig: If the products produced in 06th week of 2012, The year code & week code is 1206.

Test Circuit

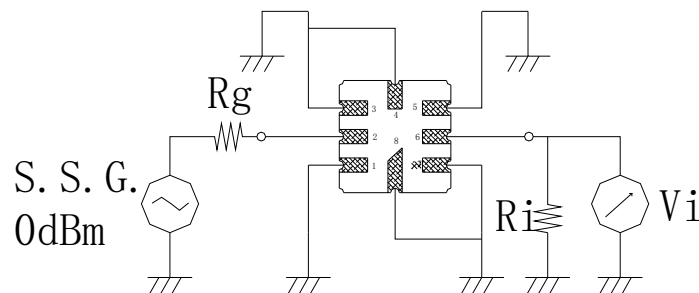

Performance**Maximum Rating**

Item		Value	Unit
DC Voltage	V _{DC}	3	V
Operation Temperature	T	-40 ~ +85	°C
Storage Temperature	T _{stg}	-55 ~ +125	°C
RF Power Dissipation	P	10	dBm

Electronic Characteristics

Test Temperature: 25°C ± 2°C

Terminating source impedance: 50Ω

Terminating load impedance: 50Ω

Item		Minimum	Typical	Maximum	Unit
Center Frequency	f _c	412.00	412.50	413.00	MHz
Insertion Loss(min)	IL		1.6	3.0	dB
Amplitude Ripple (p-p)	Δα		0.8	1.0	dB
1 dB Bandwidth	BW _{1dB}	5.0	5.4		MHz
40 dB Bandwidth	BW _{40dB}		14.2	15.0	MHz
Absolute Delay			105.0	150.0	ns
Absolute Attenuation	α				
	DC -300.00 MHz	30.0	35.0		dB
	300.00 -395.00 MHz	40.0	45.0		dB
	395.00 -405.00 MHz	30.0	35.0		dB
	420.00 -435.00 MHz	30.0	35.0		dB
	435.00-600.00 MHz	40.0	45.0		dB
	600.00-1000.00 MHz	30.0	35.0		dB
Input VSWR	410.00-415.00 MHz		1.8:1	2.0:1	/
Output VSWR	410.00-415.00 MHz		1.7:1	2.0:1	/

Frequency Characteristics

Frequency Response

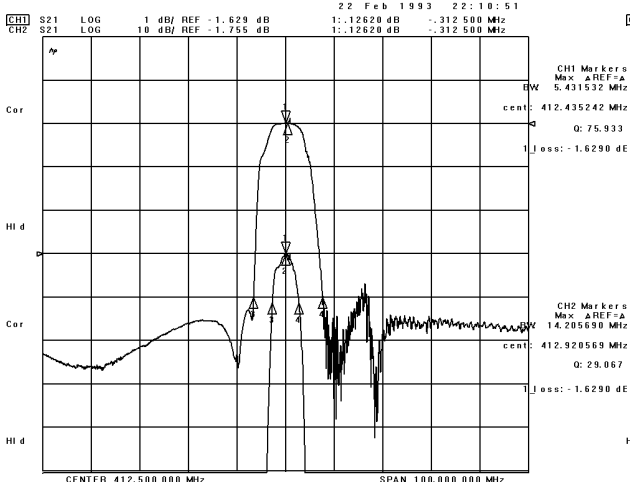

Frequency Response (wideband)

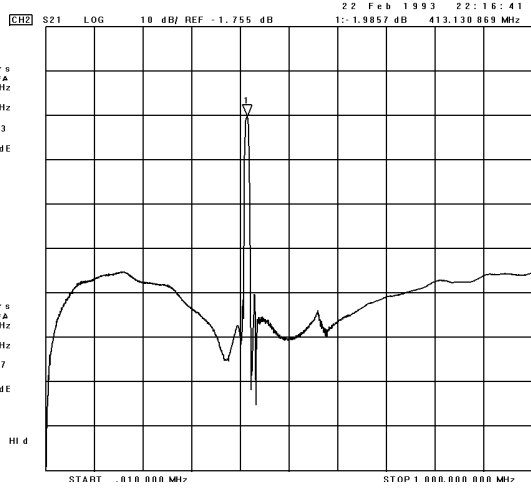

Delay Ripple & S11 VSWR

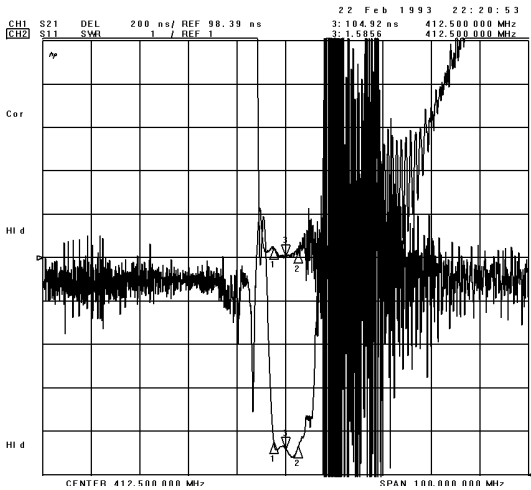

Phase Linearity & S22 VSWR

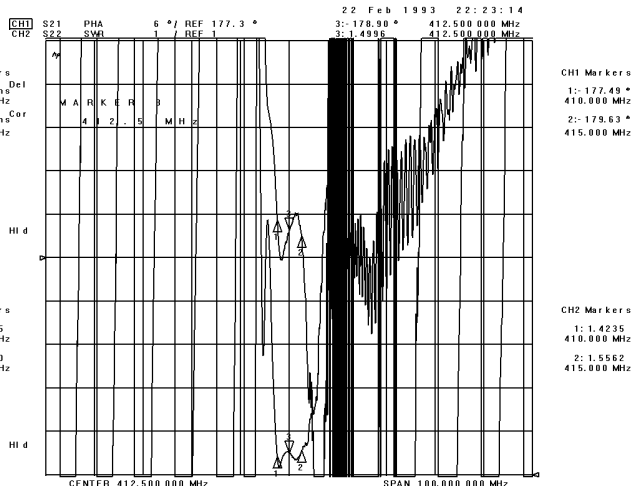

S11 Smith Chart

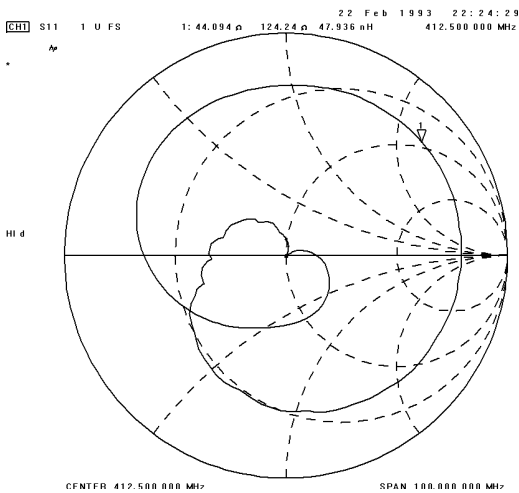

S22 Smith Chart

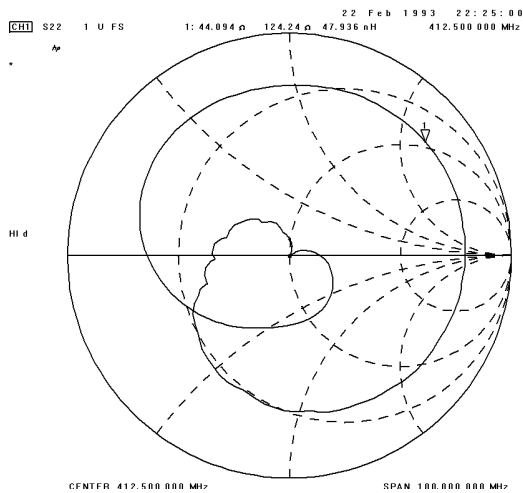

Packing Information

Carrier Tape

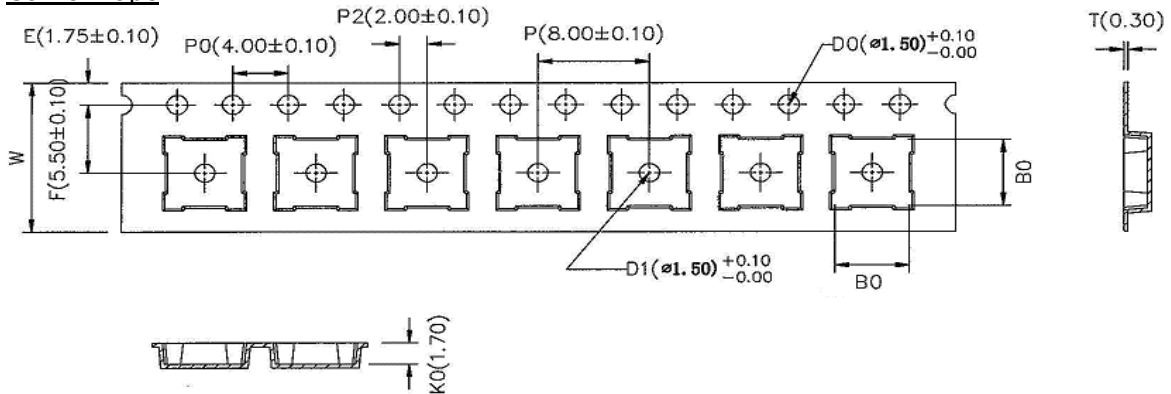

* B0: 5.35 for QCC8C; 4.15 for DCC6/QCC8B; 3.35 for DCC6C/QCC8D

Reel Dimensions

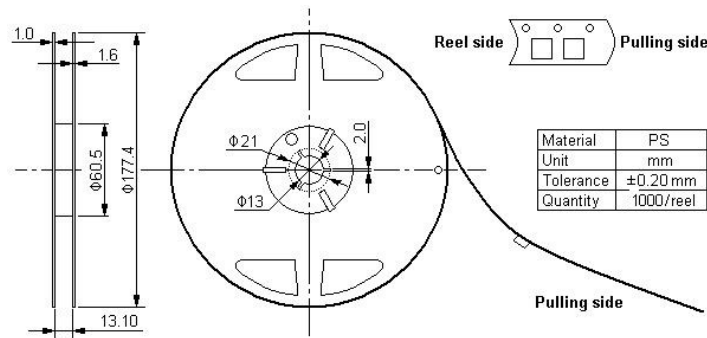

Material	PS
Unit	mm
Tolerance	±0.20 mm
Quantity	1000/reel

Outer Packing

Type	Quantity	Dimension	Description	Weight
Internal box	1000	190×188×42	carton box 2 reel / internal box	0.18
External box	10000	235×205×210	5 boxes / external box	1.80

Unit: mm

Unit: kg

Notes

1. As a result of the particularity of inner structure of SAW products, it easy to be breakdown by electrostatic, so we should pay attention to **ESD protect** in the test.
2. **Static voltage** between signal load and ground may cause deterioration and destruction of the component. Please avoid static voltage.
3. **Ultrasonic cleaning** may cause deterioration and destruction of the component. Please avoid ultrasonic cleaning.
4. Only leads of component may **be soldered**. Please avoid soldering another part of component.
5. There is a close relationship between the device's performance and **matching network**. The specifications of this device are based on the test circuit shown above. L and C values may change depending on board layout. Values shown are intended as a guide only.