



# APPROVAL SHEET

Approval Specification	Customer's Approval Certificate
<p><b>TO:</b></p> <p><b>Part No.:</b></p> <p><b>Customer's Part No.:</b></p>	<p>Please return this copy as a certification of your approval</p> <p><b>Checked &amp; Approved by:</b></p> <p><b>Date:</b></p>

## BEIJING ZHONGXUN SIFANG SCIENCE & TECHNOLOGY CO.,LTD.

Tel: +86-010-58937383  
 Fax: +86-010-58937263  
 E-mail: [bjzxsf@bjzxsf.net](mailto:bjzxsf@bjzxsf.net)  
 Website: <http://www.bjzxsf.net>  
 Add: No 201, Block A. Building 3. Yongjie Beilu  
 Yongfeng high-tech industrial base  
 Haidian District Beijing city



Part No.	:	SF7113
Pages	:	6
Date	:	2013/3/8
Revision	:	1.0

<b>Prepared by:</b>	郑宝琴
<b>Checked by:</b>	
<b>Approved by:</b>	

**Application**

- Low-loss SAW component
- Low amplitude ripple
- Sharp rejections at both out-bands
- Usable passband 8 MHz

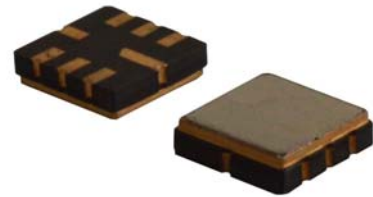

**Features**

- Ceramic Package for **Surface Mounted Technology (SMT)**
- **RoHS** compatible
- Package size 5.00x5.00x1.50mm<sup>3</sup>
- Package Code QCC8C
- **Electrostatic Sensitive Device(ESD)**

**Package Dimensions (Unit: mm)**

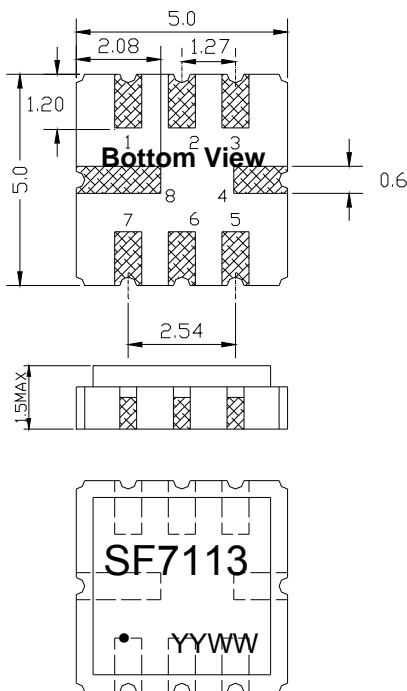

**Pin Configuration**

Pin No.	Description
2	Input
6	Output
1,3,4,5,7,8	Ground

**Marking Description**

<b>S</b>	Trademark
<b>F</b>	SAW Filter
<b>7113</b>	Part Number
●	Pin 1
<b>YYWW</b>	Year Code & Week Code

\*Fig: If the products produced in 06<sup>th</sup> week of 2012, The year code & week code is 1206.

**Test Circuit(Bottom View)**

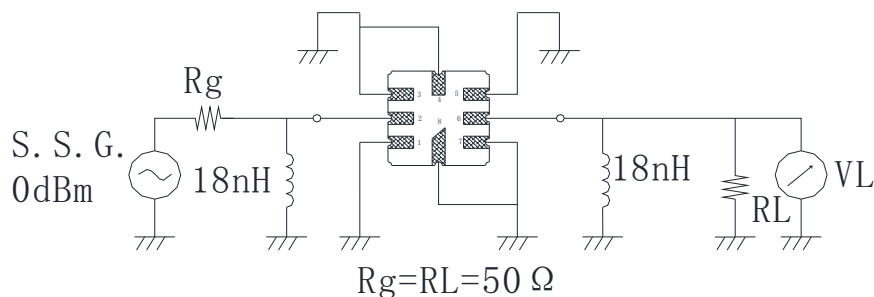

**Performance****Maximum Rating**

Item		Value	Unit
DC Voltage	$V_{DC}$	3	V
Operation Temperature	T	-40 ~ +85	°C
Storage Temperature	$T_{stg}$	-55 ~ +125	°C
RF Power Dissipation	P	10	dBm

**Electronic Characteristics**

Test Temperature:  $25^{\circ}\text{C} \pm 2^{\circ}\text{C}$

Terminating source impedance:  $50\Omega$

Terminating load impedance:  $50\Omega$

Item		Minimum	Typical	Maximum	Unit
Center Frequency	$f_c$	719.00	720.00	721.00	MHz
Insertion Loss(min)	IL		3.7	4.5	dB
Amplitude Ripple (p-p) 717.00-723.00MHz	$\Delta a$		0.9	1.5	dB
3 dB Bandwidth	$BW_{3dB}$	8.0	10.2		MHz
40 dB Bandwidth	$BW_{40dB}$		22.7	28.0	MHz
Absolute Attenuation	$a$				
	DC-705.00 MHz	38.0	45.0		dB
	735.00-1200.00MHz	38.0	45.0		dB

Frequency Characteristics

Frequency Response

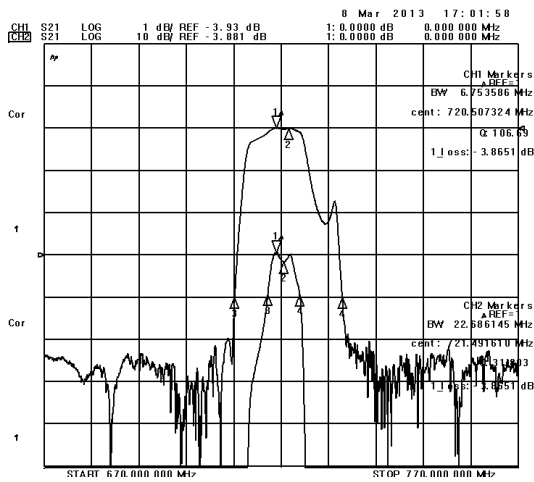

Frequency Response (wideband)

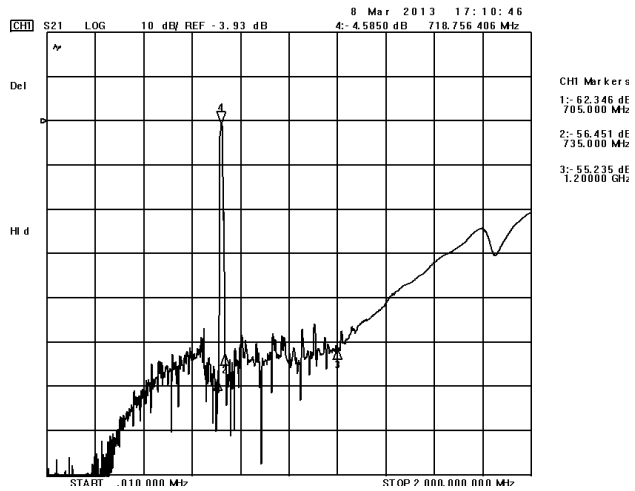

Delay Ripple & S11 VSWR

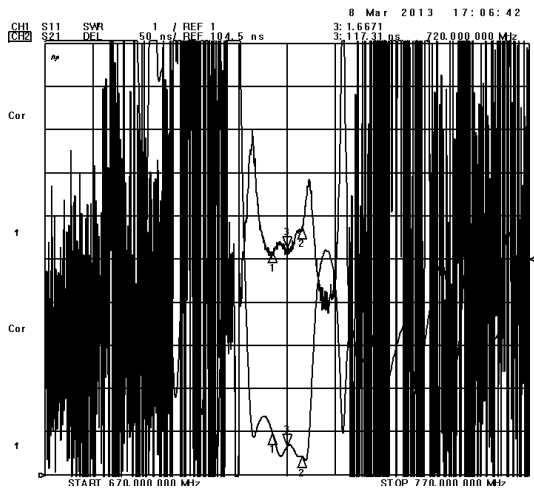

Phase Linearity & S22 VSWR

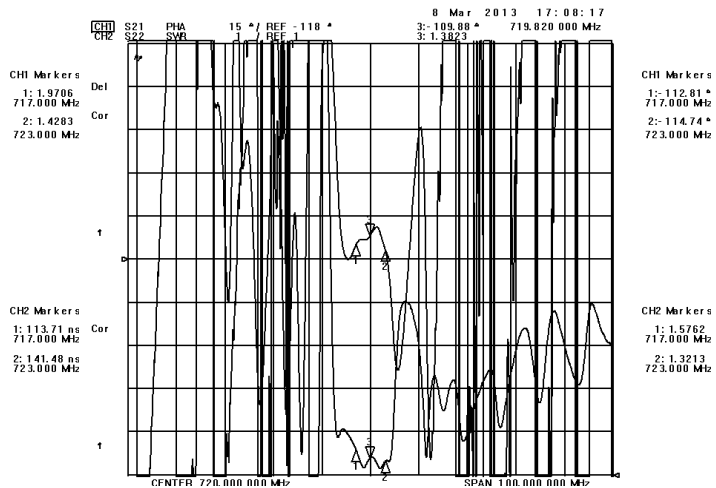

S11 Smith Chart

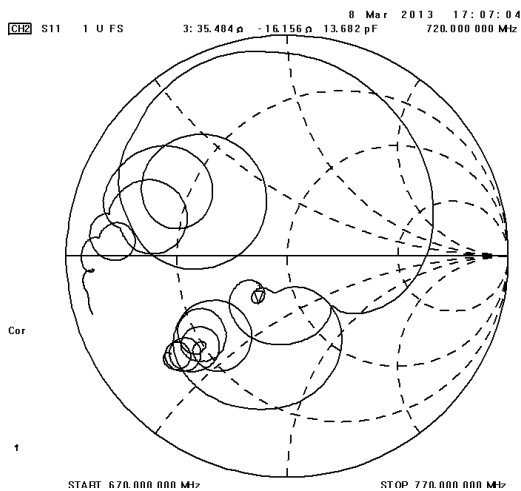

S22 Smith Chart

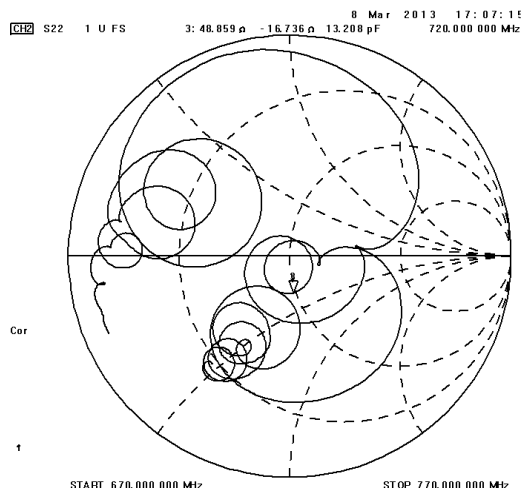

**Reliability (The SAW components shall remain electrical performance after tests)**

No.	Test item	Test condition
1	Temperature Storage	(1) Temperature: 85°C±2°C , Duration: 250h , Recovery time: 2h±0.5h (2) Temperature: -55°C±3°C , Duration: 250h ,Recovery time: 2h±0.5h
2	Humidity Test	Conditions: 60°C±2°C , 90~95% RH      Duration: 250h
3	Thermal Shock	Heat cycle conditions: TA=-55°C±3°C, TB=85°C±2°C, t1=t2=30min, Switch time: ≤3min, Cycle time: 100 times, Recovery time: 2h±0.5h.
4	Vibration Fatigue	Frequency of vibration: 10~55Hz      Amplitude:1.5mm Directions: X,Y and Z      Duration: 2h
5	Drop Test	Cycle time: 10 times      Height: 1.0m
6	Solder Ability Test	Temperature: 245°C±5°C      Duration: 3.0s--5.0s Depth: DIP--2/3 , SMD--1/5
7	Resistance to Soldering Heat	(1)Thickness of PCB:1mm , Solder condition: 260°C±5°C , Duration: 10±1s (2)Temperature of Soldering Iron: 350°C±10°C , Duration: 3~4s , Recovery time : 2 ± 0.5h

**Recommended Reflow Soldering Diagram**

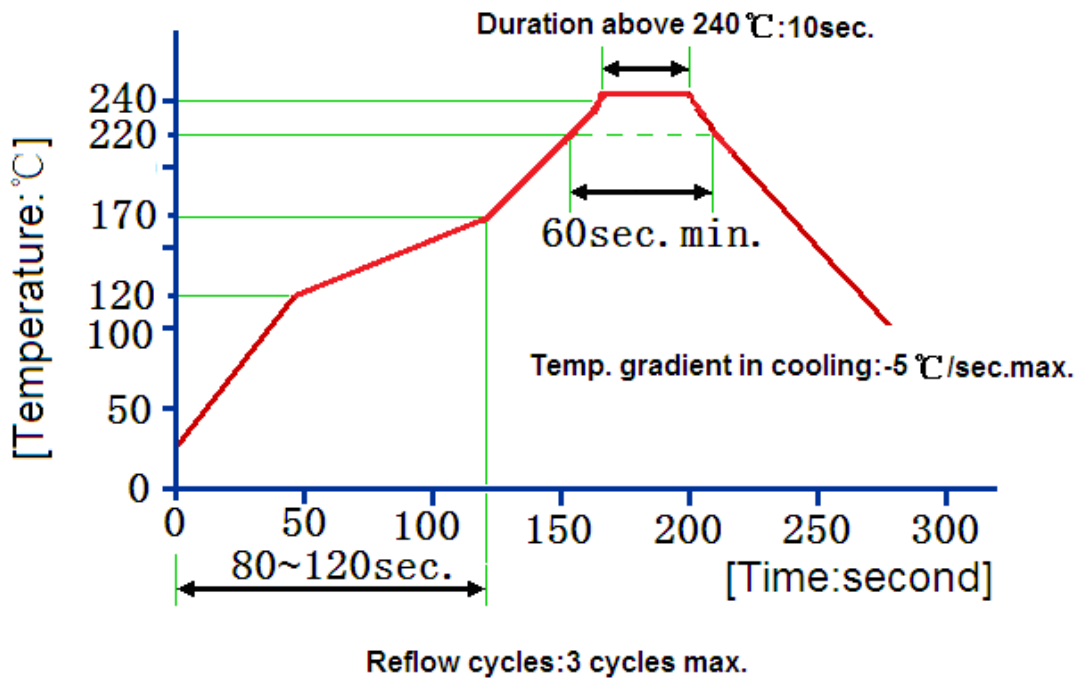

**Packing Information**

Carrier Tape

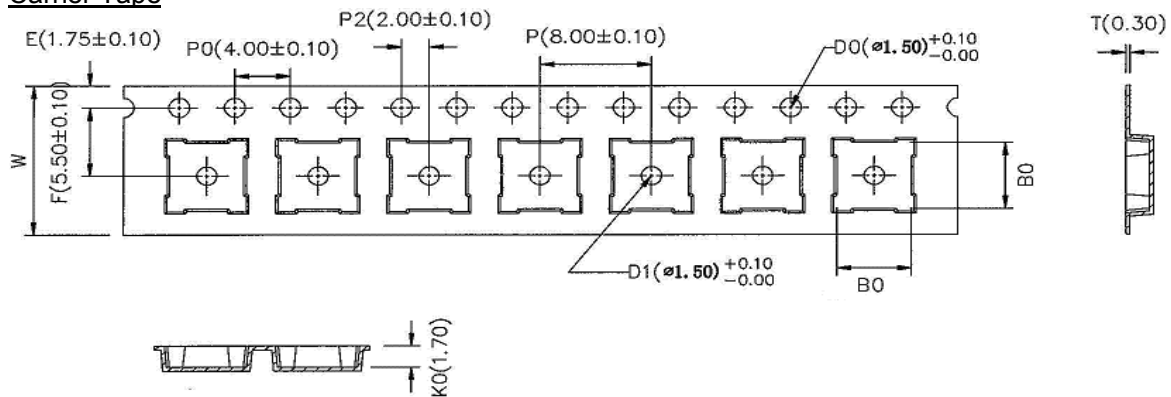

\* B0: 5.35 for QCC8C; 4.15 for DCC6/QCC8B; 3.35 for DCC6C/QCC8D

Reel Dimensions



Material	PS
Unit	mm
Tolerance	±0.20 mm
Quantity	1000/reel

Outer Packing

Type	Quantity	Dimension	Description	Weight
Internal box	1000	190×188×42	carton box	0.18
External box	10000	235×205×210	2 reel / internal box 5 boxes / external box	1.80

Unit: mm

Unit: kg

**Notes**

1. As a result of the particularity of inner structure of SAW products, it easy to be breakdown by electrostatic, so we should pay attention to **ESD protect** in the test.
2. **Static voltage** between signal load and ground may cause deterioration and destruction of the component. Please avoid static voltage.
3. **Ultrasonic cleaning** may cause deterioration and destruction of the component. Please avoid ultrasonic cleaning.
4. Only leads of component may **be soldered**. Please avoid soldering another part of component.
5. There is a close relationship between the device's performance and **matching network**. The specifications of this device are based on the test circuit shown above. L and C values may change depending on board layout. Values shown are intended as a guide only.