



APPROVAL SHEET

Approval Specification	Customer's Approval Certificate
<p>TO:</p> <p>Part No.:</p> <p>Customer's Part No.:</p>	<p>Please return this copy as a certification of your approval</p> <p>Checked & Approved by:</p> <p>Date:</p>

BEIJING ZHONGXUN SIFANG SCIENCE & TECHNOLOGY CO.,LTD.

Tel: +86-010-58937383
 Fax: +86-010-58937263
 E-mail: bjzxsf@bjzxsf.net
 Website: <http://www.bjzxsf.net>
 Add: No 201, Block A. Building 3. Yongjie Beilu
 Yongfeng high-tech industrial base
 Haidian District Beijing city



Part No.	:	SF7130
Pages	:	6
Date	:	2013/3/8
Revision	:	1.0

Prepared by:	郑宝琴
Checked by:	
Approved by:	

Application

- Low-loss SAW component
- Low amplitude ripple
- Sharp rejections at both out-bands
- Usable passband 8 MHz

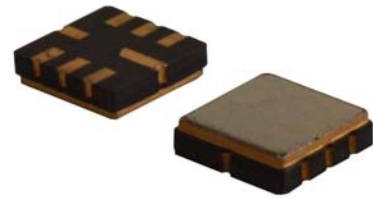

Features

- Ceramic Package for **Surface Mounted Technology (SMT)**
- **RoHS** compatible
- Package size 5.00x5.00x1.50mm³
- Package Code QCC8C
- **Electrostatic Sensitive Device(ESD)**

Package Dimensions (Unit: mm)

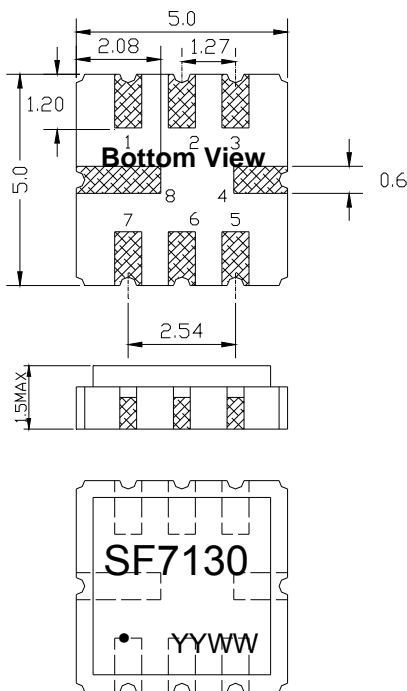

Pin Configuration

Pin No.	Description
2	Input
6	Output
1,3,4,5,7,8	Ground

Marking Description

S	Trademark
F	SAW Filter
7130	Part Number
●	Pin 1
YYWW	Year Code & Week Code

*Fig: If the products produced in 06th week of 2012, The year code & week code is 1206.

Test Circuit(Bottom View)

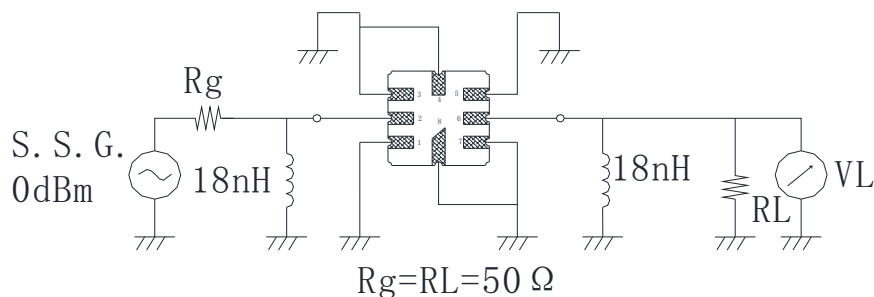

Performance**Maximum Rating**

Item		Value	Unit
DC Voltage	V_{DC}	3	V
Operation Temperature	T	-40 ~ +85	°C
Storage Temperature	T_{stg}	-55 ~ +125	°C
RF Power Dissipation	P	10	dBm

Electronic Characteristics

Test Temperature: $25^{\circ}\text{C} \pm 2^{\circ}\text{C}$

Terminating source impedance: 50Ω

Terminating load impedance: 50Ω

Item		Minimum	Typical	Maximum	Unit
Center Frequency	f_c	719.00	720.00	721.00	MHz
Insertion Loss(min)	IL		3.7	4.5	dB
Amplitude Ripple (p-p) 717.00-723.00MHz	Δa		0.9	1.5	dB
3 dB Bandwidth	BW_{3dB}	8.0	10.2		MHz
40 dB Bandwidth	BW_{40dB}		22.7	28.0	MHz
Absolute Attenuation	a				
	DC-705.00 MHz	38.0	45.0		dB
	735.00-1200.00MHz	38.0	45.0		dB
Input VSWR	717.00-723.00MHz		1.9:1	2.0:1	/
Output VSWR	717.00-723.00MHz		1.7:1	2.0:1	/

Frequency Characteristics

Frequency Response

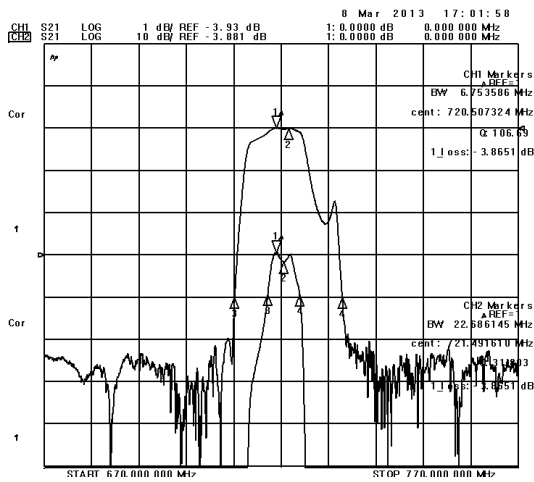

Frequency Response (wideband)

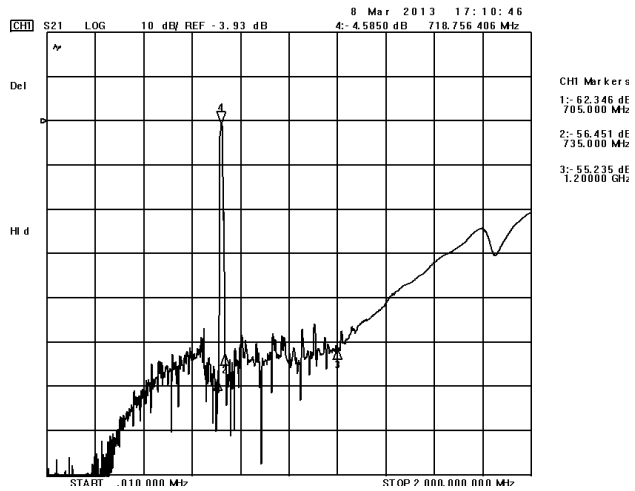

Delay Ripple & S11 VSWR

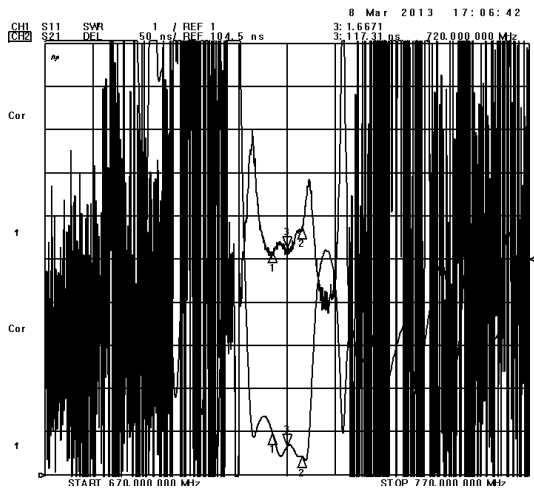

Phase Linearity & S22 VSWR

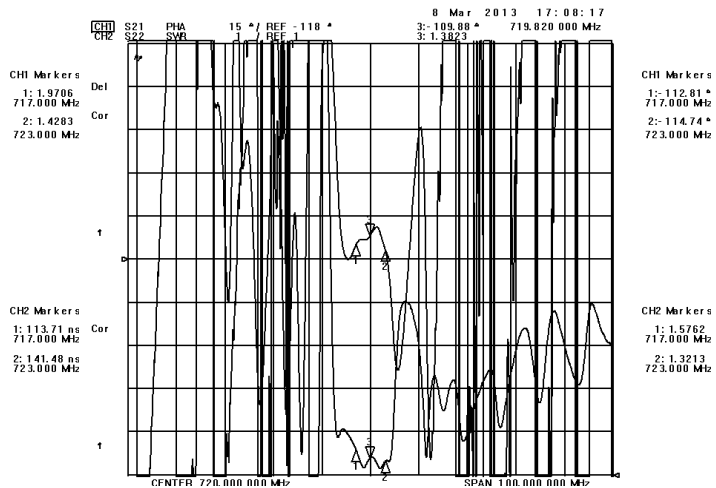

S11 Smith Chart

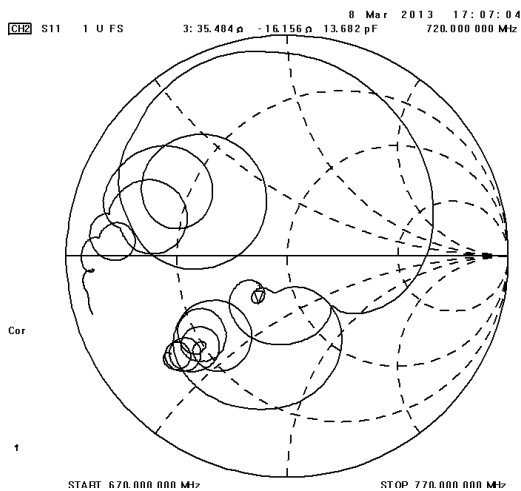

S22 Smith Chart

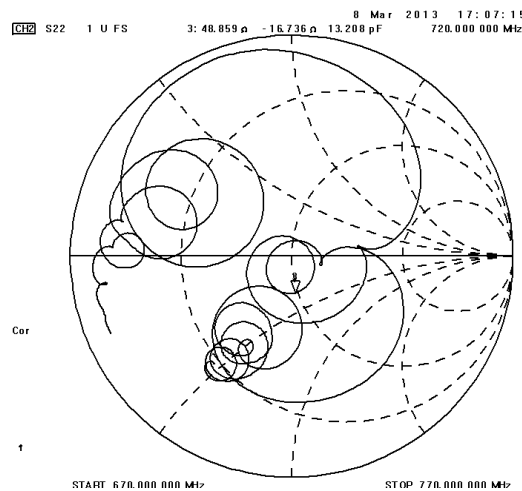

Packing Information

Carrier Tape



* B0: 5.35 for QCC8C; 4.15 for DCC6/QCC8B; 3.35 for DCC6C/QCC8D

Reel Dimensions

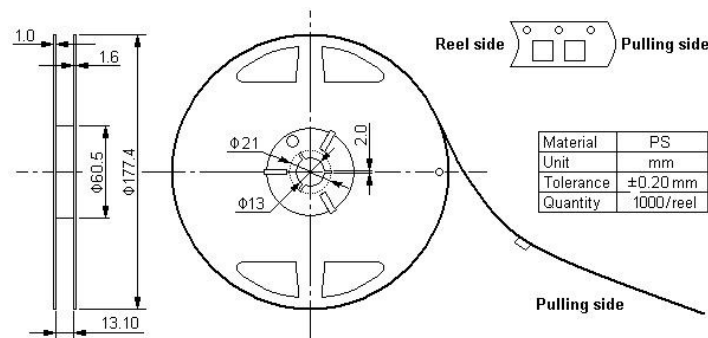

Outer Packing

Type	Quantity	Dimension	Description	Weight
Internal box	1000	190×188×42	carton box 2 reel / internal box	0.18
External box	10000	235×205×210	5 boxes / external box	1.80

Unit: mm

Unit: kg

Notes

1. As a result of the particularity of inner structure of SAW products, it easy to be breakdown by electrostatic, so we should pay attention to **ESD protect** in the test.
2. **Static voltage** between signal load and ground may cause deterioration and destruction of the component. Please avoid static voltage.
3. **Ultrasonic cleaning** may cause deterioration and destruction of the component. Please avoid ultrasonic cleaning.
4. Only leads of component may **be soldered**. Please avoid soldering another part of component.
5. There is a close relationship between the device's performance and **matching network**. The specifications of this device are based on the test circuit shown above. L and C values may change depending on board layout. Values shown are intended as a guide only.