



APPROVAL SHEET

| Approval Specification | Customer's Approval Certificate |
|--|---|
| <p>TO:</p> <p>Part No.:</p> <p>Customer's Part No.:</p> | <p>Please return this copy as a certification of your approval</p> <p>Checked & Approved by:</p> <p>Date:</p> |

BEIJING ZHONGXUN SIFANG SCIENCE & TECHNOLOGY CO.,LTD.

Tel: +86-010-58937383
 Fax: +86-010-58937263
 E-mail: bjzxsf@bjzxsf.net
 Website: <http://www.bjzxsf.net>
 Add: No 201, Block A. Building 3. Yongjie Beilu
 Yongfeng high-tech industrial base
 Haidian District Beijing city



| | | |
|----------|---|-----------|
| Part No. | : | SF1422 |
| Pages | : | 6 |
| Date | : | 2014/9/22 |
| Revision | : | 1.0 |

| | |
|---------------------|----|
| Prepared by: | 梁浩 |
| Checked by: | |
| Approved by: | |

Application

- Low-loss SAW component
- Low amplitude ripple
- Sharp rejections at both out-bands
- Usable passband 42 MHz

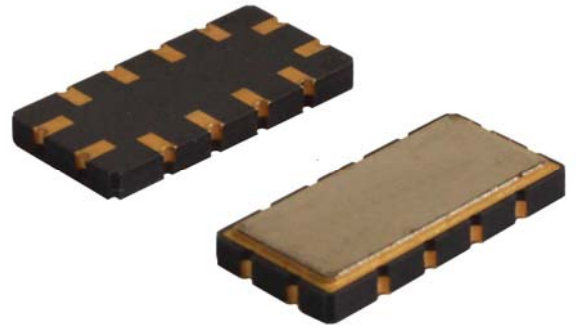

Features

- Ceramic Package for **Surface Mounted Technology (SMT)**
- **RoHS** compatible
- Package size 13.30x6.50x1.80mm³
- Package Code QCC12
- **Electrostatic Sensitive Device(ESD)**

Package Dimensions (Unit: mm)

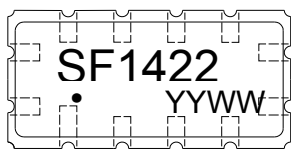
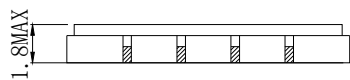
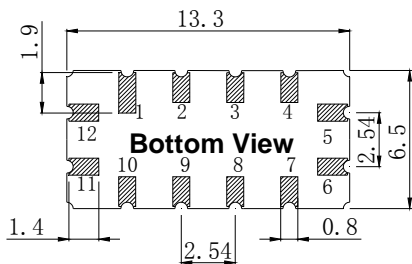

Pin Configuration

| Pin No. | Description |
|-----------------------|-------------|
| 11 | Input |
| 5 | Output |
| 1,2,3,4,6,7,8,9,10,12 | Ground |

Marking Description

| | |
|-------------|-----------------------|
| S | Trademark |
| F | SAW Filter |
| 1422 | Part Number |
| ● | Pin 1 |
| YYWW | Year Code & Week Code |

*Fig: If the products produced in 06th week of 2012, The year code & week code is 1206.

Test Circuit(Bottom View)

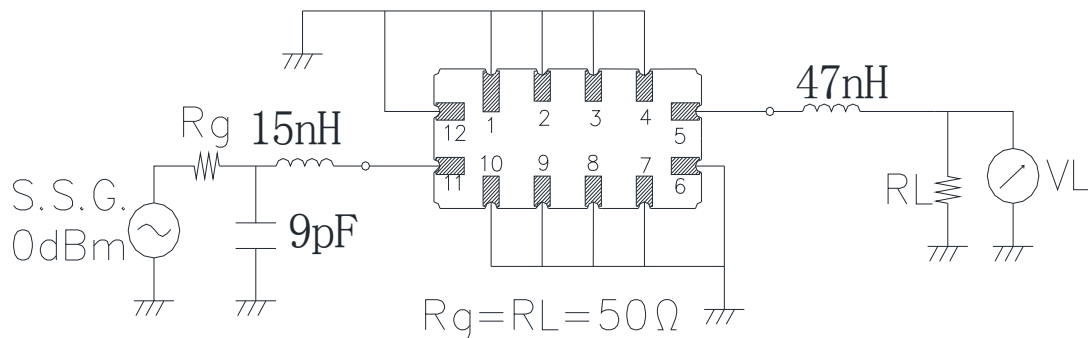

Performance**Maximum Rating**

| Item | | Value | Unit |
|-----------------------|------------------|------------|------|
| DC Voltage | V _{DC} | 3 | V |
| Operation Temperature | T | -40 ~ +70 | °C |
| Storage Temperature | T _{stg} | -55 ~ +125 | °C |
| RF Power Dissipation | P | 10 | dBm |

Electronic Characteristics

Test Temperature: 25°C ± 2°C

Terminating source impedance: 50Ω

Terminating load impedance: 50Ω

| Item | | Minimum | Typical | Maximum | Unit |
|---------------------|--------------------|---------|---------|---------|------|
| Center Frequency | f _c | | 110.0 | | MHz |
| Insertion Loss(min) | IL | | 18.2 | 19.0 | dB |
| 1 dB Bandwidth | BW _{1dB} | 42.0 | 43.0 | | MHz |
| 40 dB Bandwidth | BW _{40dB} | | 58.2 | 60.0 | MHz |

Frequency Characteristics

Frequency Response

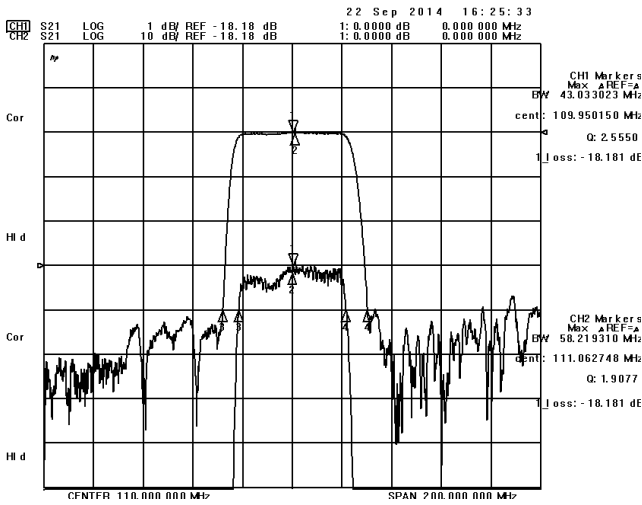

Frequency Response (wideband)

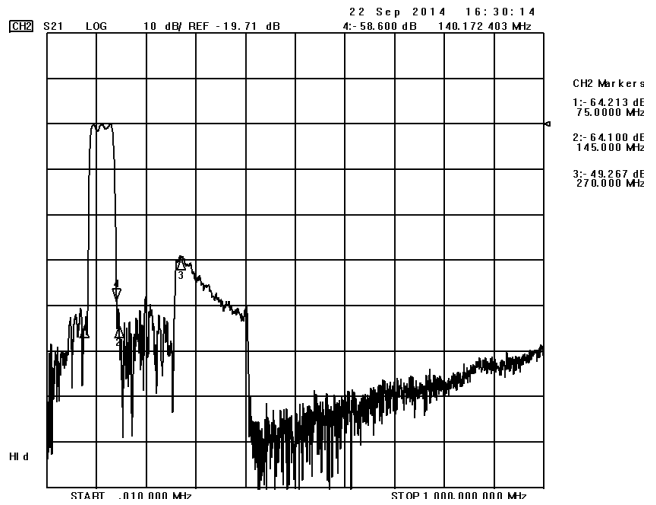

Delay Ripple & S11 VSWR

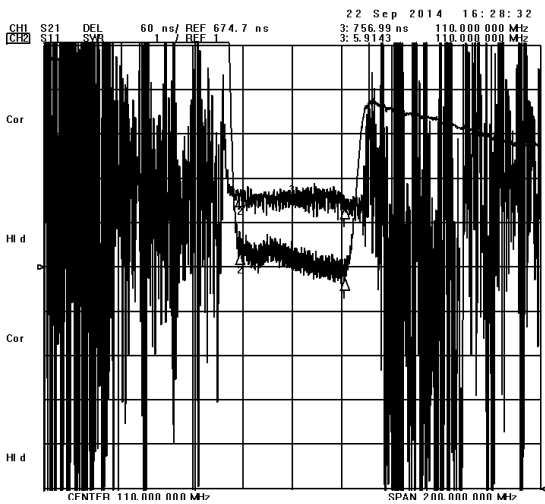

Phase Linearity & S22 VSWR

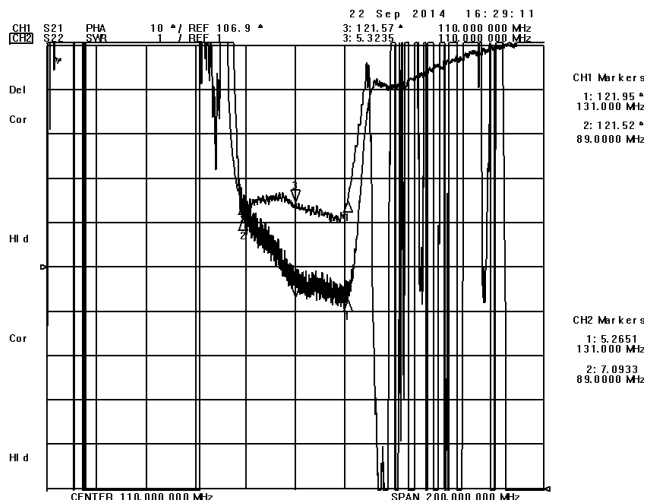

S11 Smith Chart

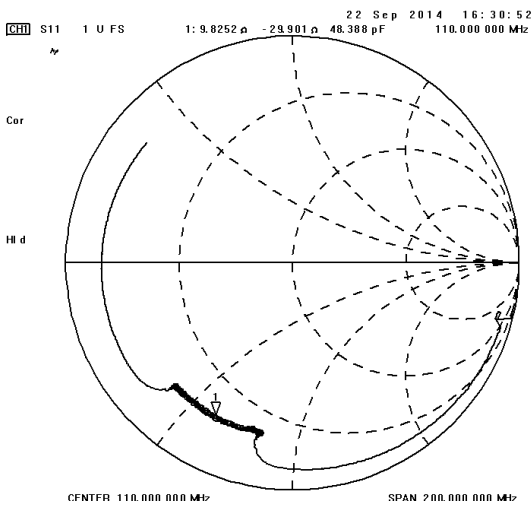

S22 Smith Chart

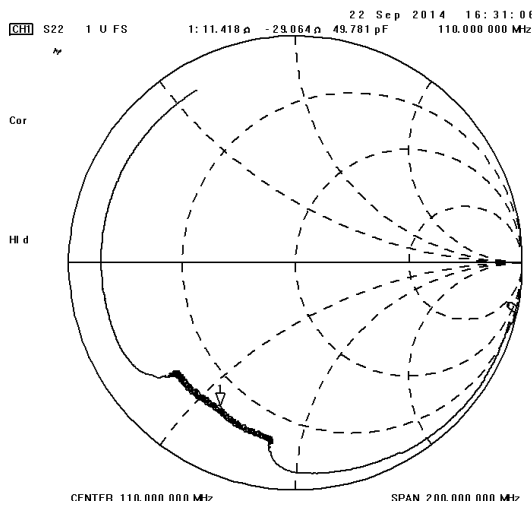

Notes

1. As a result of the particularity of inner structure of SAW products, it easy to be breakdown by electrostatic, so we should pay attention to **ESD protect** in the test.
2. **Static voltage** between signal load and ground may cause deterioration and destruction of the component. Please avoid static voltage.
3. **Ultrasonic cleaning** may cause deterioration and destruction of the component. Please avoid ultrasonic cleaning.
4. Only leads of component may **be soldered**. Please avoid soldering another part of component.
5. There is a close relationship between the device's performance and **matching network**. The specifications of this device are based on the test circuit shown above. L and C values may change depending on board layout. Values shown are intended as a guide only.