



APPROVAL SHEET

| Approval Specification | Customer's Approval Certificate |
|--|---|
| <p>TO:</p> <p>Part No.:</p> <p>Customer's Part No.:</p> | <p>Please return this copy as a certification of your approval</p> <p>Checked & Approved by:</p> <p>Date:</p> |

BEIJING ZHONGXUN SIFANG SCIENCE & TECHNOLOGY CO.,LTD.

Tel: +86-010-58937383
 Fax: +86-010-58937263
 E-mail: bjzxsf@bjzxsf.net
 Website: <http://www.bjzxsf.net>
 Add: No 201, Block A. Building 3. Yongjie Beilu
 Yongfeng high-tech industrial base
 Haidian District Beijing city



| | | |
|----------|---|----------|
| Part No. | : | SF0395 |
| Pages | : | 6 |
| Date | : | 2014/1/7 |
| Revision | : | 1.0 |

| | |
|---------------------|-----|
| Prepared by: | 郑宝琴 |
| Checked by: | |
| Approved by: | |

Application

- Low-loss SAW component
- Low amplitude ripple
- Sharp rejections at both out-bands
- Usable passband 280 KHz

Features

- RoHS compatible
- Package size 36.0x16.0x5.50mm³
- Package Code SB01-01
- Electrostatic Sensitive Device(ESD)



Package Dimensions (Unit: mm)

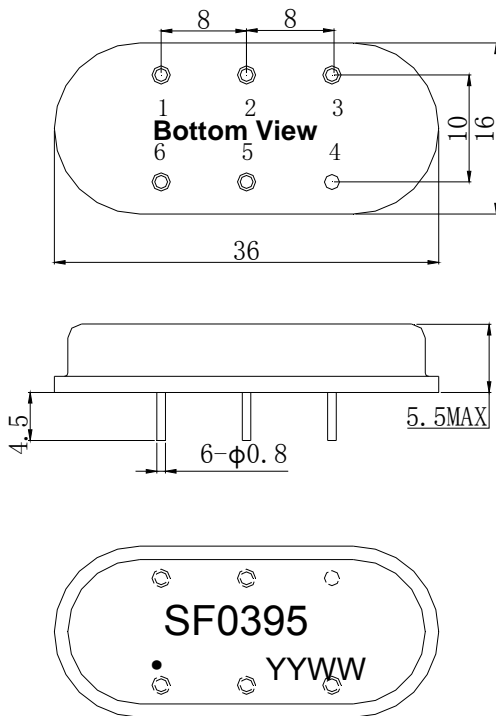

Pin Configuration

| Pin No. | Description |
|---------|-------------|
| 6 | Input |
| 3 | Output |
| 1,2,4,5 | Ground |

Marking Description

| | |
|-------------|-----------------------|
| S | Trademark |
| F | SAW Filter |
| 0395 | Part Number |
| ● | Pin 1 |
| YYWW | Year Code & Week Code |

*Fig: If the products produced in 06th week of 2012, The year code & week code is 1206.

Test Circuit(Bottom View)

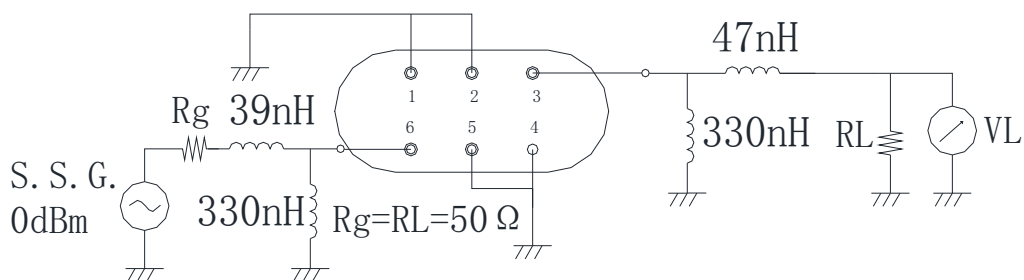

Performance**Maximum Rating**

| Item | | Value | Unit |
|-----------------------|-----------|------------|------|
| DC Voltage | V_{DC} | 3 | V |
| Operation Temperature | T | -40 ~ +85 | °C |
| Storage Temperature | T_{stg} | -55 ~ +125 | °C |
| RF Power Dissipation | P | 10 | dBm |

Electronic Characteristics

Test Temperature: $25^{\circ}\text{C} \pm 2^{\circ}\text{C}$

Terminating source impedance: 50Ω

Terminating load impedance: 50Ω

| Item | | Minimum | Typical | Maximum | Unit |
|----------------------|-----------------|---------|---------|---------|------|
| Center Frequency | fc | 21.3 | 21.4 | 21.5 | MHz |
| Insertion Loss(min) | IL | | 8.5 | 10.0 | dB |
| Amplitude Ripple | $\Delta\alpha$ | | 0.2 | 0.5 | dB |
| 3 dB Bandwidth | BW_{3dB} | 0.28 | 0.30 | 0.34 | MHz |
| 40 dB Bandwidth | BW_{40dB} | | 0.88 | 1.00 | MHz |
| Group Delay Ripple | GDR | | 300 | 400 | ns |
| Absolute Attenuation | α | | | | |
| | 17.40-19.90 MHz | 50.0 | 60.0 | | dB |
| | 22.90-25.40MHz | 50.0 | 60.0 | | dB |

Frequency Characteristics

Frequency Response

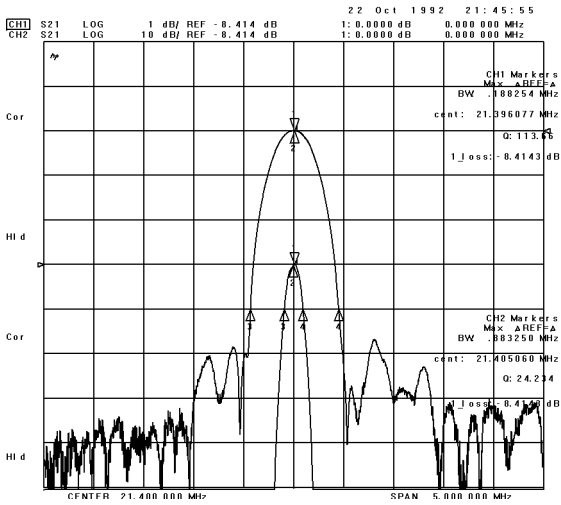

Frequency Response (wideband)

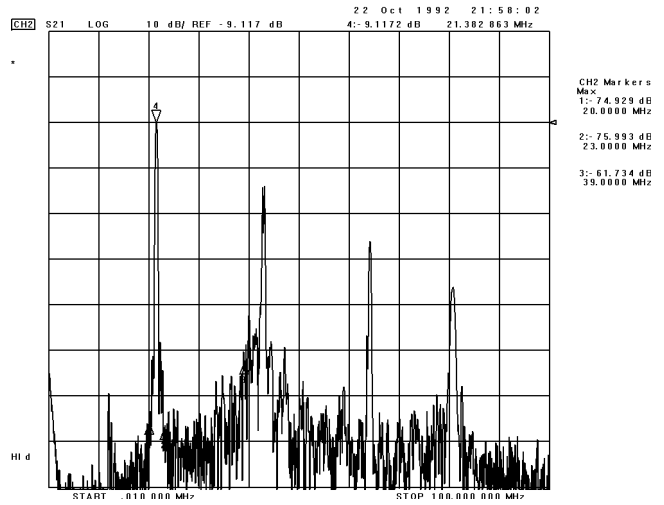

Delay Ripple & S11 VSWR

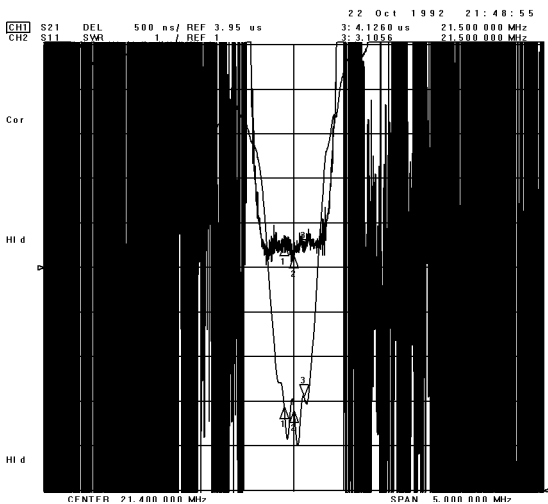

Phase Linearity & S22 VSWR

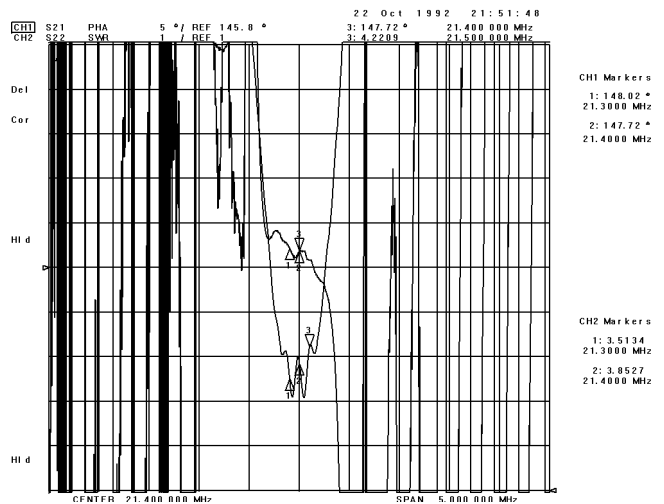

S11 Smith Chart

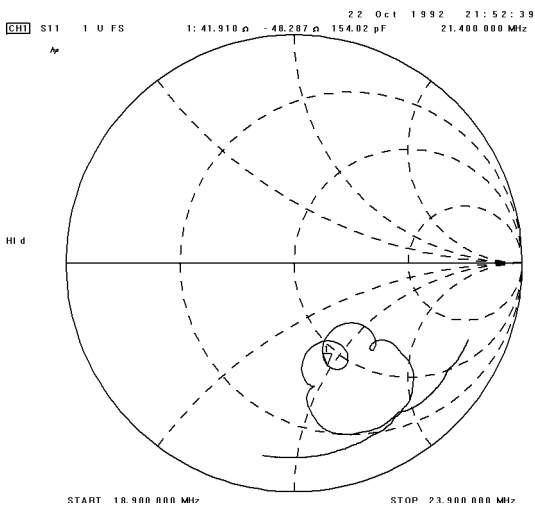

S22 Smith Chart

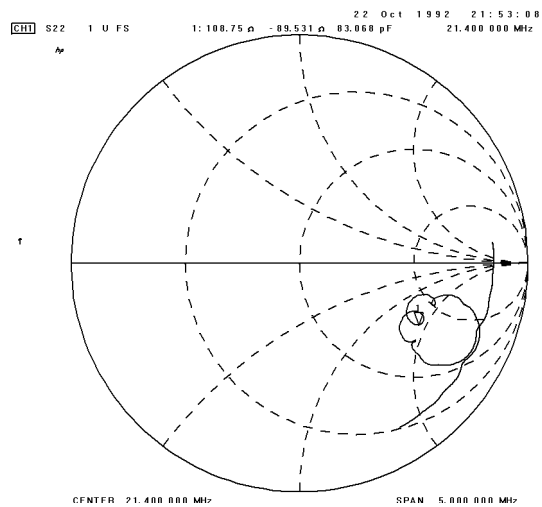

Notes

1. As a result of the particularity of inner structure of SAW products, it easy to be breakdown by electrostatic, so we should pay attention to **ESD protect** in the test.
2. **Static voltage** between signal load and ground may cause deterioration and destruction of the component. Please avoid static voltage.
3. **Ultrasonic cleaning** may cause deterioration and destruction of the component. Please avoid ultrasonic cleaning.
4. Only leads of component may **be soldered**. Please avoid soldering another part of component.
5. There is a close relationship between the device's performance and **matching network**. The specifications of this device are based on the test circuit shown above. L and C values may change depending on board layout. Values shown are intended as a guide only.