



# APPROVAL SHEET

Approval Specification	Customer's Approval Certificate
<p><b>TO:</b></p> <p><b>Part No.:</b></p> <p><b>Customer's Part No.:</b></p>	<p>Please return this copy as a certification of your approval</p> <p><b>Checked &amp; Approved by:</b></p> <p><b>Date:</b></p>

## BEIJING ZHONGXUN SIFANG SCIENCE & TECHNOLOGY CO.,LTD.

Tel: +86-010-62968745  
 Fax: +86-010-62973654  
 E-mail: [bjzxsf@bjzxsf.net](mailto:bjzxsf@bjzxsf.net)  
 Website: <http://www.bjzxsf.net>  
 Add: NO.7 NieGeZhuang Rd,SuJiaTuo Town,  
 HaiDian District,Beijing,P.R.China



Part No.	:	SF0315
Pages	:	6
Date	:	2013/8/5
Revision	:	1.0

<b>Prepared by:</b>	郑宝琴
<b>Checked by:</b>	
<b>Approved by:</b>	

**Application**

- Low-loss SAW component
- Low amplitude ripple
- Sharp rejections at both out-bands
- Usable passband 20 MHz

**Features**

- Ceramic Package for **Surface Mounted Technology (SMT)**
- **RoHS** compatible
- Package size 13.30x6.50x1.80mm<sup>3</sup>
- Package Code QCC12
- **Electrostatic Sensitive Device(ESD)**

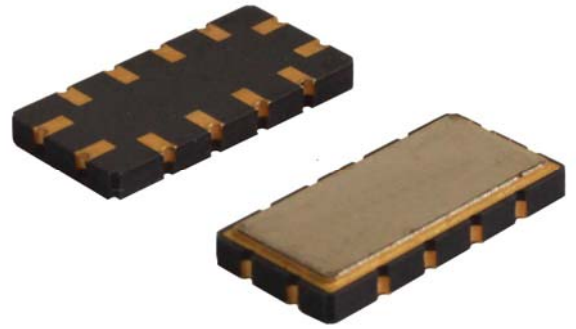

**Package Dimensions (Unit: mm)**

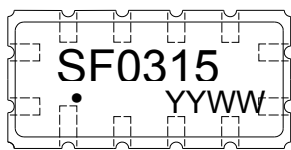
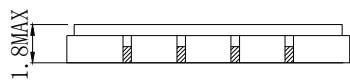
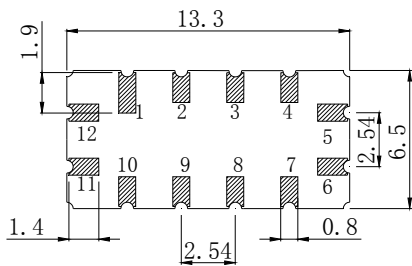

**Pin Configuration**

Pin No.	Description
11	Input
5	Output
1,2,3,4,6,7,8,9,10,12	Ground

**Marking Description**

<b>S</b>	Trademark
<b>F</b>	SAW Filter
<b>0315</b>	Part Number
●	Pin 1
<b>YYWW</b>	Year Code & Week Code

**Test Circuit (Bottom View)**

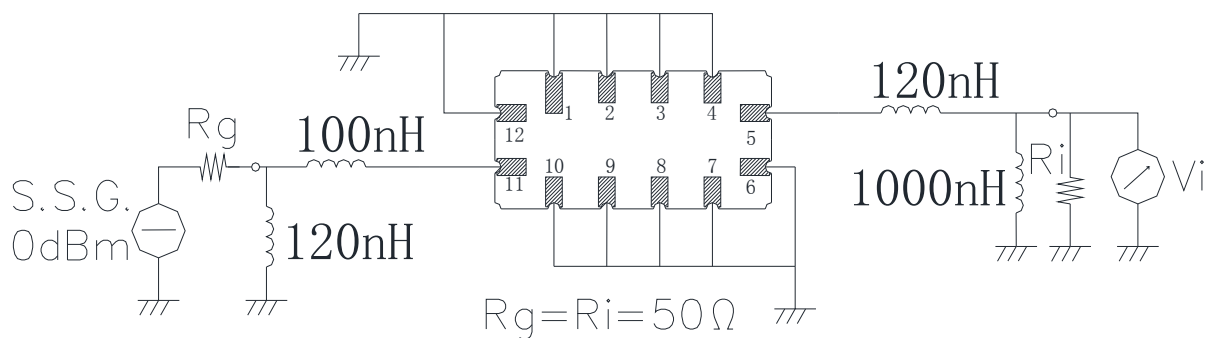

\*Fig: If the products produced in 06<sup>th</sup> week of 2012, The year code & week code is 1206.

**Performance****Maximum Rating**

Item		Value	Unit
DC Voltage	V <sub>DC</sub>	3	V
Operation Temperature	T	-40 ~ +85	°C
Storage Temperature	T <sub>stg</sub>	-55 ~ +125	°C
RF Power Dissipation	P	10	dBm

**Electronic Characteristics**

Test Temperature: 25°C ± 2°C

Terminating source impedance: 50Ω

Terminating load impedance: 50Ω

Item		Minimum	Typical	Maximum	Unit
Center Frequency	f <sub>c</sub>	49.75	50.0	50.25	MHz
Insertion Loss(min)	IL		16.3	16.5	dB
Amplitude Ripple (p-p) 40.50-59.50MHz	Δα		1.2	1.5	dB
1.5 dB Bandwidth	BW <sub>1.5dB</sub>	19.5	20.1		MHz
3 dB Bandwidth	BW <sub>3dB</sub>	20.5	20.8		MHz
40 dB Bandwidth	BW <sub>40dB</sub>		25.0	30.0	MHz
Absolute Attenuation	α				
	35.00 MHz	30.0	45.0		dB
	65.00MHz	30.0	46.0		dB
	1000.00 MHz	55.0	60.0		dB
Input VSWR	41.00-59.00MHz		5.8:1	7.5:1	/
Output VSWR	41.00-59.00MHz		6.0:1	7.5:1	/

Frequency Characteristics

Frequency Response

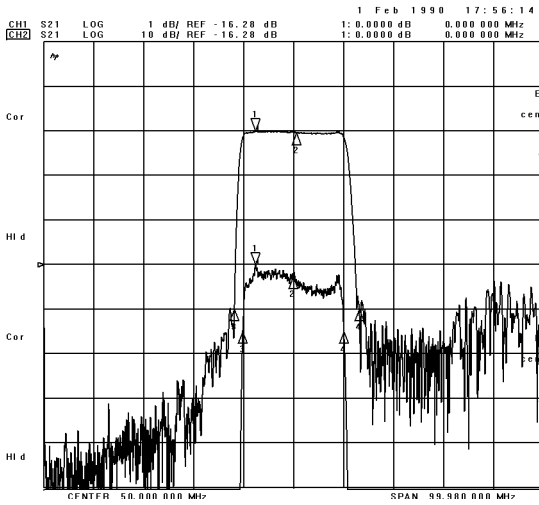

Frequency Response (wideband)

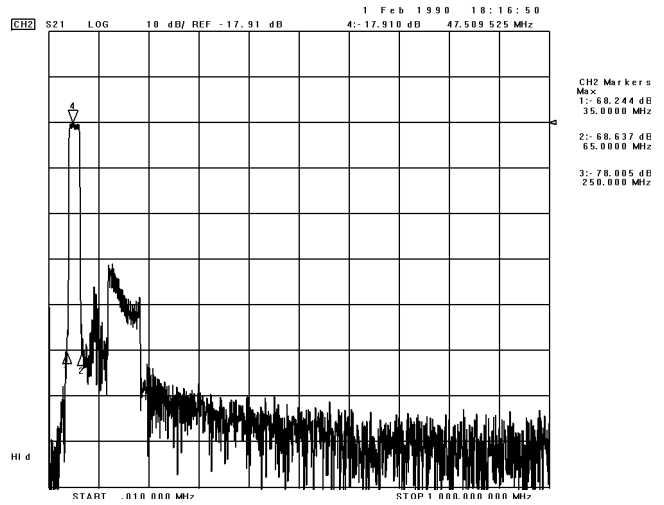

Delay Ripple & S11 VSWR

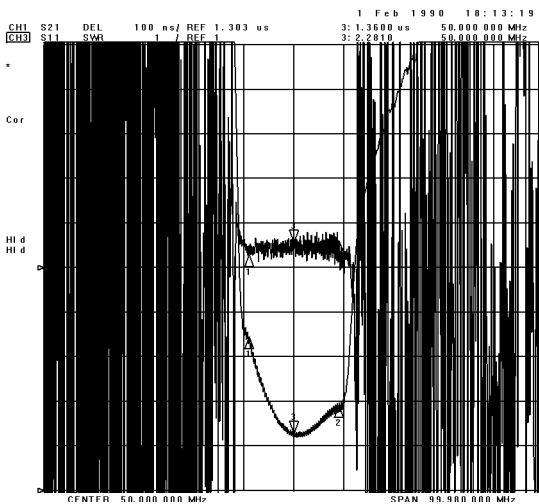

Phase Linearity & S22 VSWR

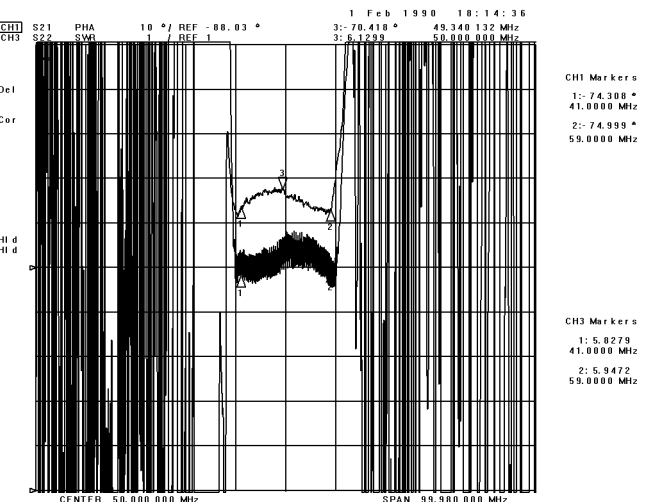

S11 Smith Chart

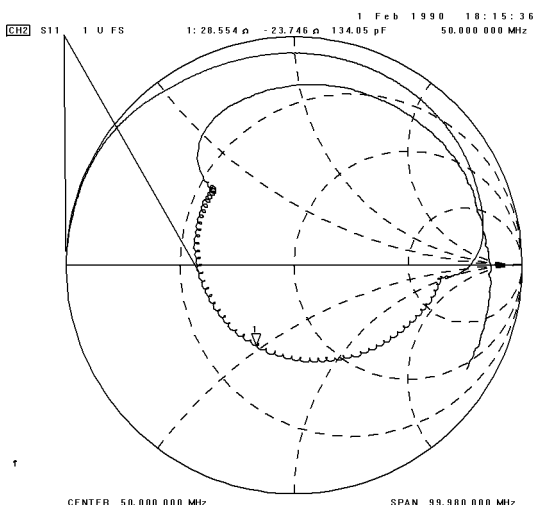

S22 Smith Chart

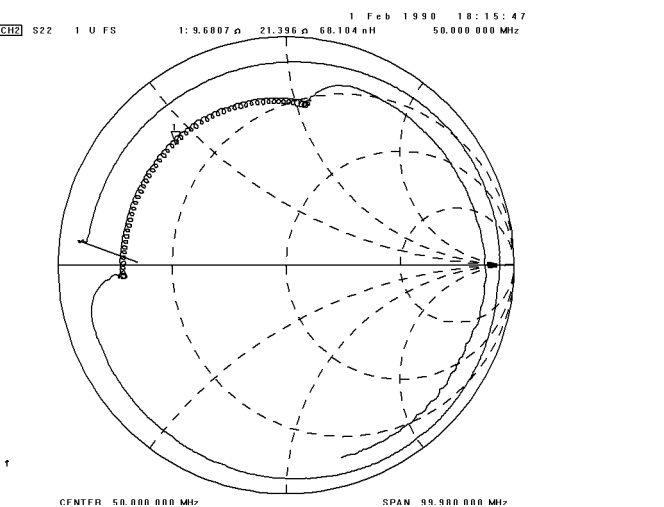



**Notes**

1. As a result of the particularity of inner structure of SAW products, it easy to be breakdown by electrostatic, so we should pay attention to **ESD protect** in the test.
2. **Static voltage** between signal load and ground may cause deterioration and destruction of the component. Please avoid static voltage.
3. **Ultrasonic cleaning** may cause deterioration and destruction of the component. Please avoid ultrasonic cleaning.
4. Only leads of component may **be soldered**. Please avoid soldering another part of component.
5. There is a close relationship between the device's performance and **matching network**. The specifications of this device are based on the test circuit shown above. L and C values may change depending on board layout. Values shown are intended as a guide only.