



# APPROVAL SHEET

Approval Specification	Customer's Approval Certificate
<p><b>TO:</b></p> <p><b>Part No.:</b></p> <p><b>Customer's Part No.:</b></p>	<p>Please return this copy as a certification of your approval</p> <p><b>Checked &amp; Approved by:</b></p> <p><b>Date:</b></p>

## BEIJING ZHONGXUN SIFANG SCIENCE & TECHNOLOGY CO.,LTD.

Tel: +86-010-58937383  
 Fax: +86-010-58937263  
 E-mail: [bjzxsf@bjzxsf.net](mailto:bjzxsf@bjzxsf.net)  
 Website: <http://www.bjzxsf.net>  
 Add: No 201, Block A. Building 3. Yongjie Beilu  
 Yongfeng high-tech industrial base  
 Haidian District Beijing city



Part No.	:	SF0410
Pages	:	6
Date	:	2014/4/30
Revision	:	1.0

<b>Prepared by:</b>	梁浩
<b>Checked by:</b>	
<b>Approved by:</b>	

**Application**

- Low-loss SAW component
- Low amplitude ripple
- Sharp rejections at both out-bands
- Usable passband 3 MHz

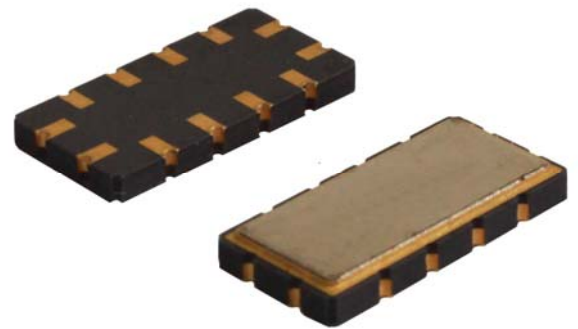

**Features**

- Ceramic Package for **Surface Mounted Technology (SMT)**
- **RoHS** compatible
- Package size 13.30x6.50x1.80mm<sup>3</sup>
- Package Code QCC12
- **Electrostatic Sensitive Device(ESD)**

**Package Dimensions (Unit: mm)**

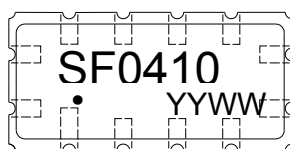
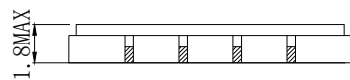
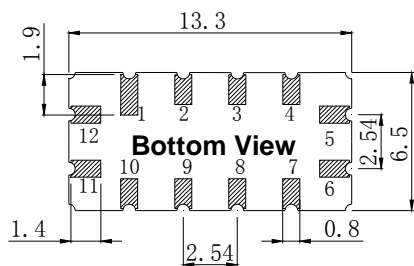

**Pin Configuration**

Pin No.	Description
11	Input
5	Output
1,2,3,4,6,7,8,9,10,12	Ground

**Marking Description**

<b>S</b>	Trademark
<b>F</b>	SAW Filter
<b>0410</b>	Part Number
●	Pin 1
<b>YYWW</b>	Year Code & Week Code

\*Fig: If the products produced in 06<sup>th</sup> week of 2012, The year code & week code is 1206.

**Test Circuit(Bottom View)**

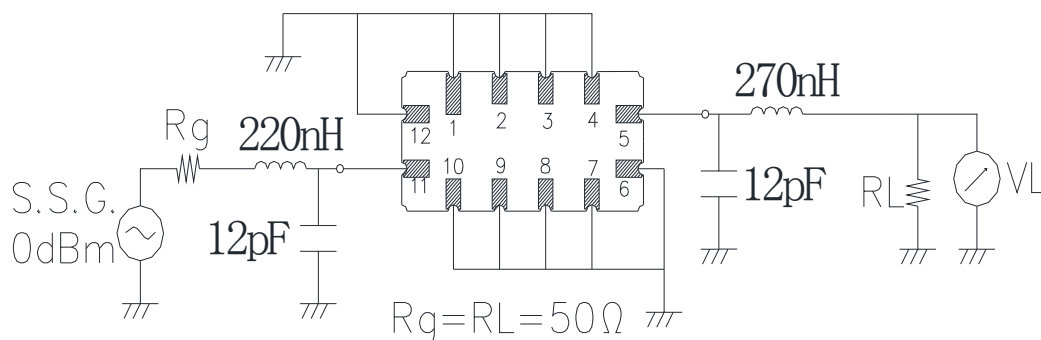

**Performance****Maximum Rating**

Item		Value	Unit
DC Voltage	$V_{DC}$	3	V
Operation Temperature	T	-10 ~ +55	°C
Storage Temperature	$T_{stg}$	-55 ~ +125	°C
RF Power Dissipation	P	10	dBm

**Electronic Characteristics**

Test Temperature:  $25^{\circ}\text{C} \pm 2^{\circ}\text{C}$

Terminating source impedance:  $50\Omega$

Terminating load impedance:  $50\Omega$

Item		Minimum	Typical	Maximum	Unit
Center Frequency	$f_c$	64.9	65.0	65.1	MHz
Insertion Loss(min)	IL		2.9	3.0	dB
Amplitude Ripple	$\Delta\alpha$		0.8	1.0	dB
1 dB Bandwidth	$BW_{1dB}$	3.00	3.19		MHz
40 dB Bandwidth	$BW_{40dB}$		9.44	12.00	MHz
Absolute Attenuation	$\alpha$				
	40.00-60.00 MHz	40.0	50.0		dB
	75.00-90.00 MHz	40.0	55.0		dB

Frequency Characteristics

Frequency Response

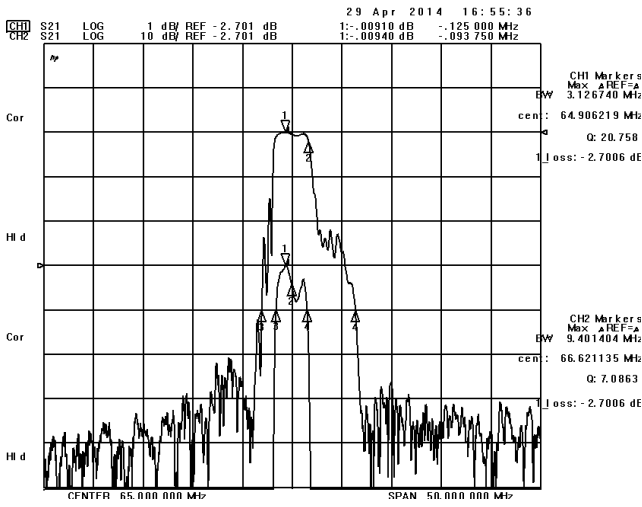

Frequency Response (wideband)

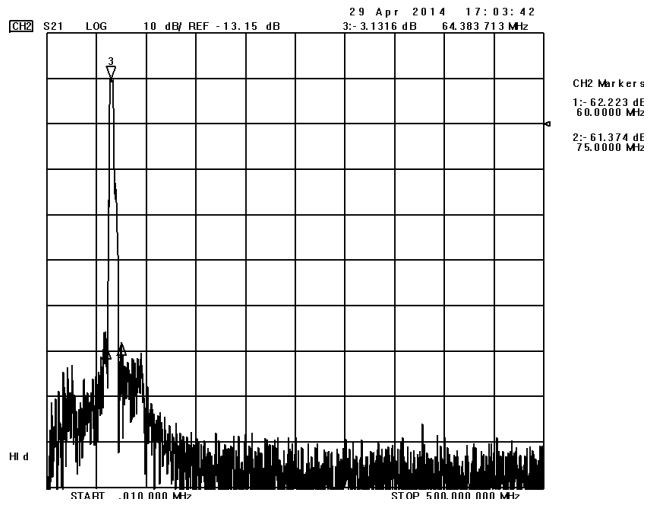

Delay Ripple & S11 VSWR

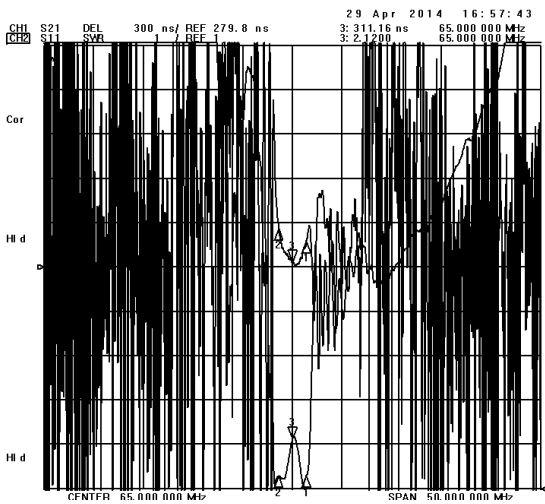

Phase Linearity & S22 VSWR

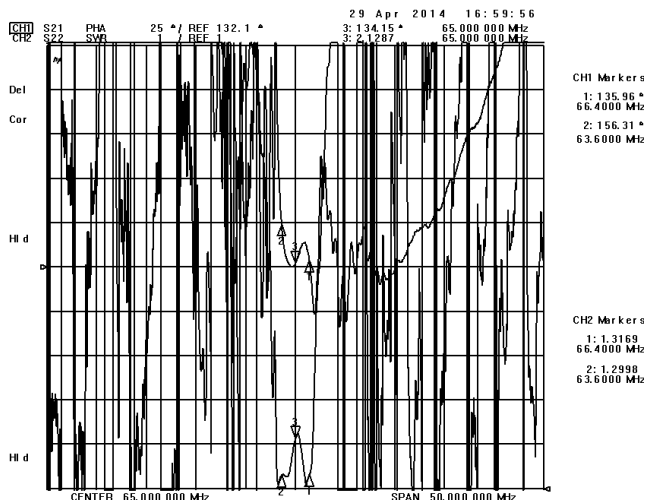

S11 Smith Chart

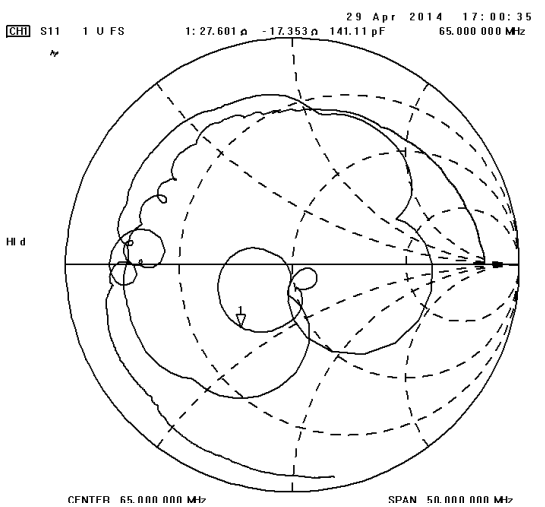

S22 Smith Chart

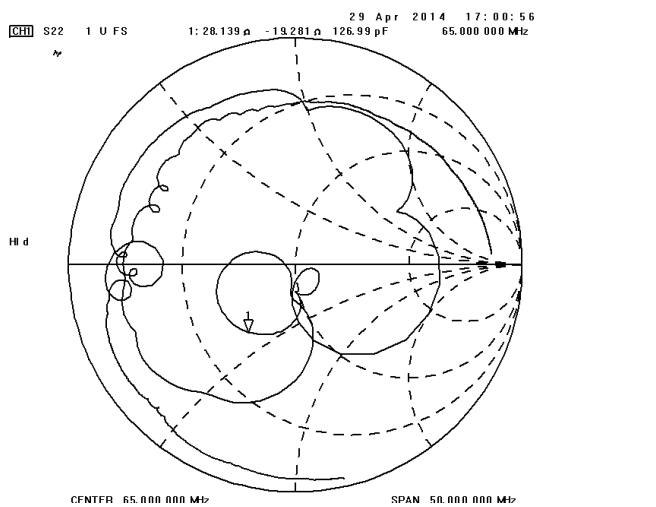



**Notes**

1. As a result of the particularity of inner structure of SAW products, it easy to be breakdown by electrostatic, so we should pay attention to **ESD protect** in the test.
2. **Static voltage** between signal load and ground may cause deterioration and destruction of the component. Please avoid static voltage.
3. **Ultrasonic cleaning** may cause deterioration and destruction of the component. Please avoid ultrasonic cleaning.
4. Only leads of component may **be soldered**. Please avoid soldering another part of component.
5. There is a close relationship between the device's performance and **matching network**. The specifications of this device are based on the test circuit shown above. L and C values may change depending on board layout. Values shown are intended as a guide only.