



# APPROVAL SHEET

Approval Specification	Customer's Approval Certificate
<p><b>TO:</b></p> <p><b>Part No.:</b></p> <p><b>Customer's Part No.:</b></p>	<p>Please return this copy as a certification of your approval</p> <p><b>Checked &amp; Approved by:</b></p> <p><b>Date:</b></p>

## BEIJING ZHONGXUN SIFANG SCIENCE & TECHNOLOGY CO.,LTD.

Tel: +86-010-62968745  
 Fax: +86-010-62973654  
 E-mail: [bjzxsf@bjzxsf.net](mailto:bjzxsf@bjzxsf.net)  
 Website: <http://www.bjzxsf.net>  
 Add: NO.7 NieGeZhuang Rd,SuJiaTuo Town,  
 HaiDian District,Beijing,P.R.China



Part No.	:	SF3184
Pages	:	6
Date	:	2013/8/2
Revision	:	1.0

<b>Prepared by:</b>	郑宝琴
<b>Checked by:</b>	
<b>Approved by:</b>	

**Application**

- Low-loss SAW component
- Low amplitude ripple
- Sharp rejections at both out-bands
- Usable passband 6 MHz



**Features**

- Ceramic Package for **Surface Mounted Technology (SMT)**
- **RoHS** compatible
- Package size 5.00x5.00x1.50mm<sup>3</sup>
- Package Code QCC8C
- **Electrostatic Sensitive Device(ESD)**

**Package Dimensions (Unit: mm)**

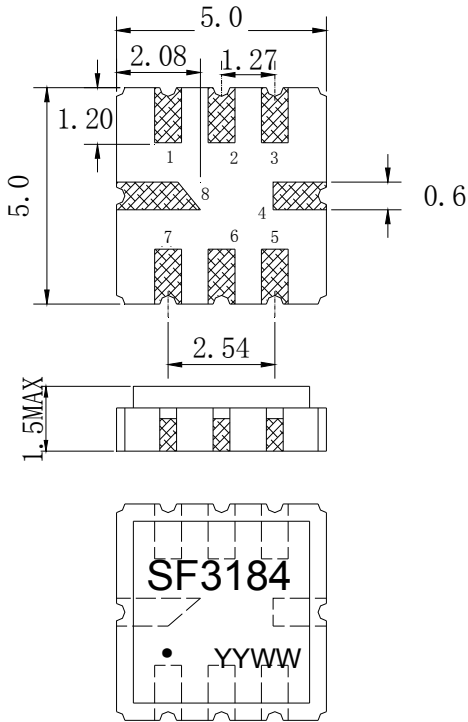

**Pin Configuration**

Pin No.	Description
2	Input
6	Output
1,3,4,5,7,8	Ground

**Marking Description**

<b>S</b>	Trademark
<b>F</b>	SAW Filter
<b>3184</b>	Part Number
●	Pin 1
<b>YYWW</b>	Year Code & Week Code

\*Fig: If the products produced in 06<sup>th</sup> week of 2012, The year code & week code is 1206.

**Test Circuit (Bottom View)**

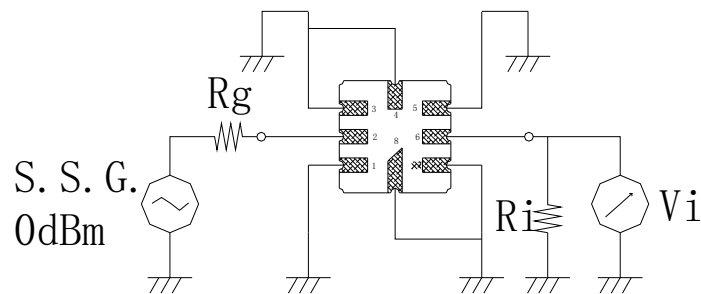

**Performance****Maximum Rating**

Item		Value	Unit
DC Voltage	V <sub>DC</sub>	3	V
Operation Temperature	T	-40 ~ +85	°C
Storage Temperature	T <sub>stg</sub>	-55 ~ +125	°C
RF Power Dissipation	P	10	dBm

**Electronic Characteristics**

Test Temperature: 25°C ± 2°C

Terminating source impedance: 50Ω

Terminating load impedance: 50Ω

Item		Minimum	Typical	Maximum	Unit
Center Frequency	f <sub>c</sub>	306.2	307.0	307.8	MHz
Insertion Loss(min)	IL		1.3	3.0	dB
1 dB Bandwidth	BW <sub>1dB</sub>	6.0	6.7		MHz
Phase Linearity 304.00-310.00MHz			8.0	16.0	deg
Absolute Attenuation	α				
10.00-297.00 MHz		35.0	43.0		dB
317.00-327.00MHz		20.0	45.0		dB
327.00-507.00 MHz		40.0	50.0		dB
Input VSWR 304.00-310.00MHz			1.7:1	2.5:1	/
Output VSWR 304.00-310.00MHz			1.7:1	2.5:1	/

Frequency Characteristics

Frequency Response

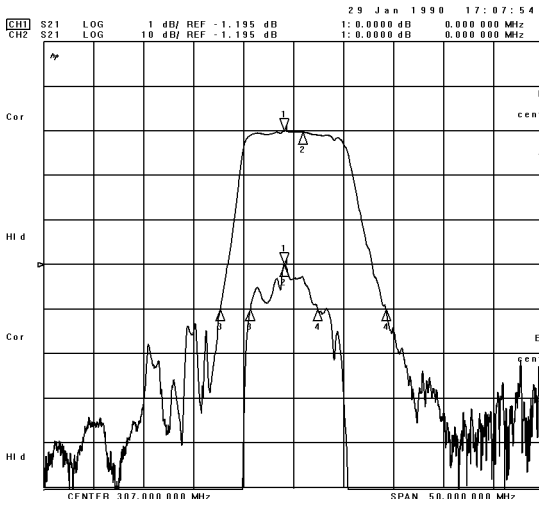

Frequency Response (wideband)

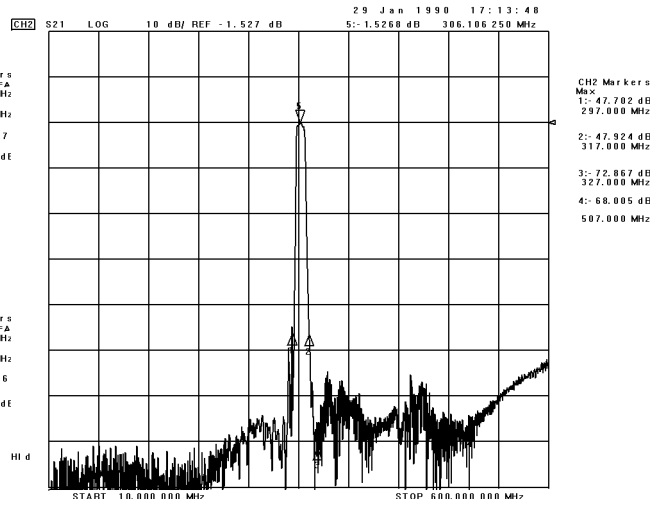

Delay Ripple & S11 VSWR

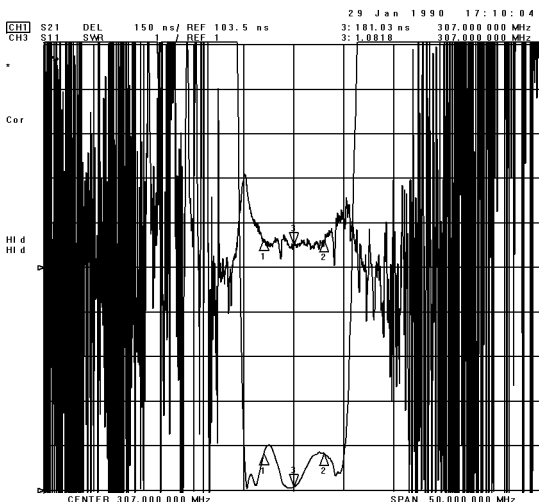

Phase Linearity & S22 VSWR

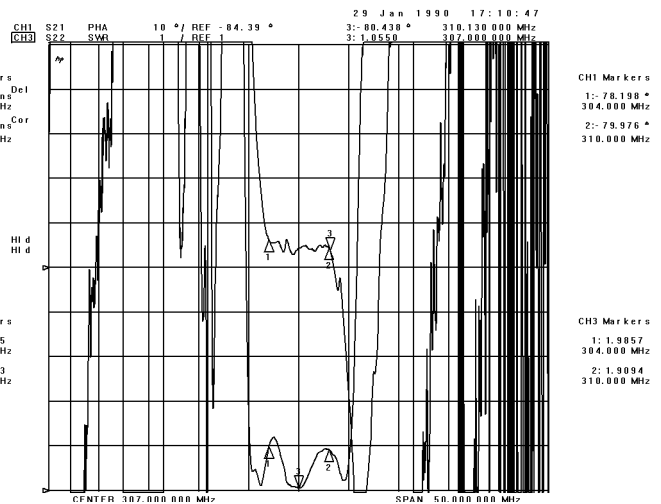

S11 Smith Chart

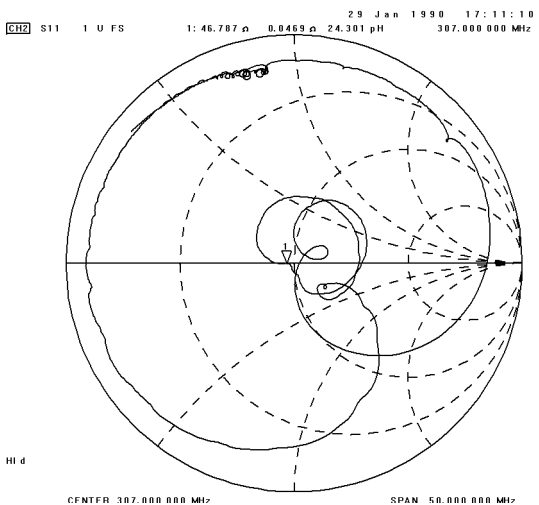

S22 Smith Chart

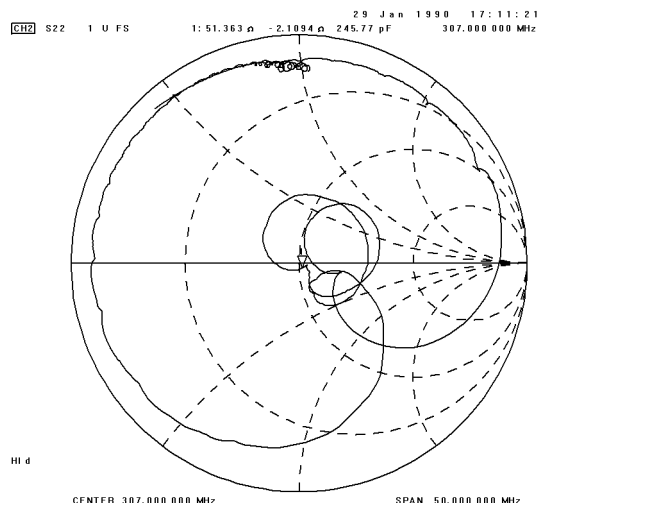



**Packing Information**

Carrier Tape

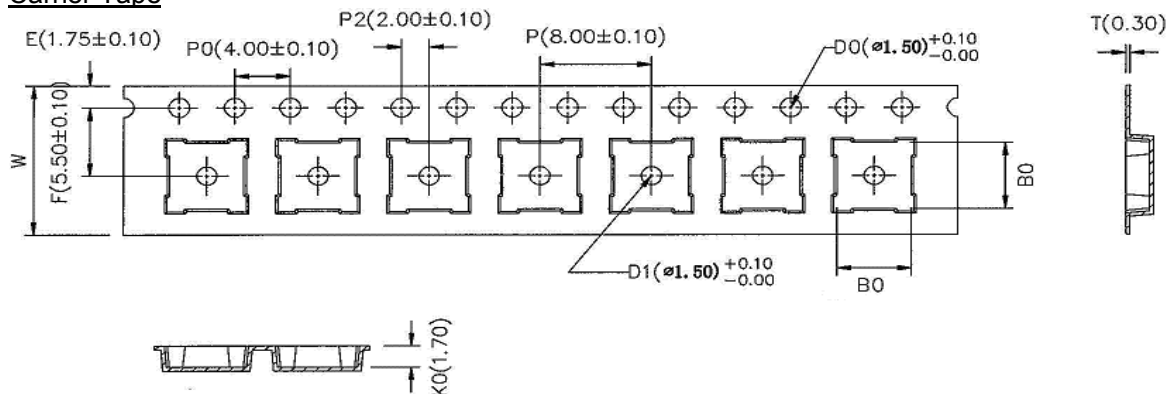

\* B0: 5.35 for QCC8C; 4.15 for DCC6/QCC8B; 3.35 for DCC6C/QCC8D

Reel Dimensions

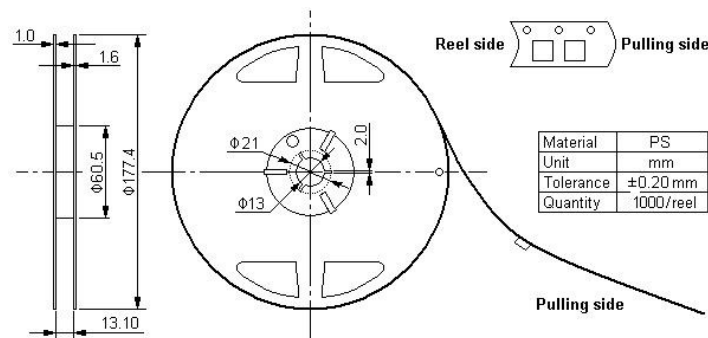

Outer Packing

Type	Quantity	Dimension	Description	Weight
Internal box	1000	190×188×42	carton box	0.18
External box	10000	235×205×210	2 reel / internal box 5 boxes / external box	

Unit: mm

Unit: kg

**Notes**

1. As a result of the particularity of inner structure of SAW products, it easy to be breakdown by electrostatic, so we should pay attention to **ESD protect** in the test.
2. **Static voltage** between signal load and ground may cause deterioration and destruction of the component. Please avoid static voltage.
3. **Ultrasonic cleaning** may cause deterioration and destruction of the component. Please avoid ultrasonic cleaning.
4. Only leads of component may **be soldered**. Please avoid soldering another part of component.
5. There is a close relationship between the device's performance and **matching network**. The specifications of this device are based on the test circuit shown above. L and C values may change depending on board layout. Values shown are intended as a guide only.