



APPROVAL SHEET

Approval Specification	Customer's Approval Certificate
<p>TO:</p> <p>Part No.:</p> <p>Customer's Part No.:</p>	<p>Please return this copy as a certification of your approval</p> <p>Checked & Approved by:</p> <p>Date:</p>

BEIJING ZHONGXUN SIFANG SCIENCE & TECHNOLOGY CO.,LTD.

Tel: +86-010-62968745
 Fax: +86-010-62973654
 E-mail: bjzxsf@bjzxsf.net
 Website: <http://www.bjzxsf.net>
 Add: NO.7 NieGeZhuang Rd,SuJiaTuo Town,
 HaiDian District,Beijing,P.R.China



Part No.	:	SF0337
Pages	:	6
Date	:	2013/5/8
Revision	:	1.0

Prepared by:	
Checked by:	
Approved by:	

Application

- Low amplitude ripple
- Sharp rejections at both out-bands
- Usable passband 16.4 MHz

Features

- Ceramic Package for **Surface Mounted Technology (SMT)**
- **RoHS** compatible
- Package size 13.30x6.50x1.80mm³
- Package Code QCC12
- **Electrostatic Sensitive Device(ESD)**

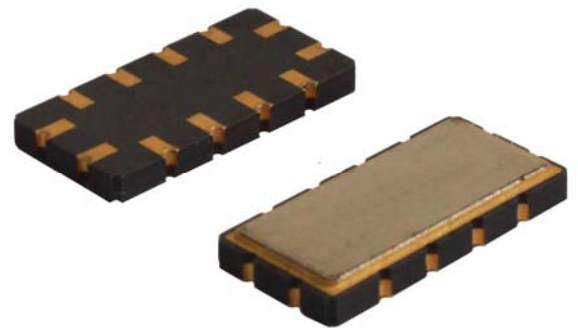

Package Dimensions (Unit: mm)

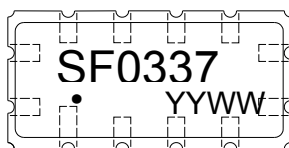
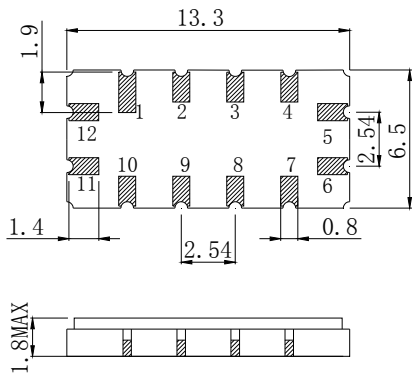

Pin Configuration

Pin No.	Description
11	Input
5	Output
1,2,3,4,6,7,8,9,10,12	Ground

Marking Description

S	Trademark
F	SAW Filter
0337	Part Number
●	Pin 1
YYWW	Year Code & Week Code

Test Circuit

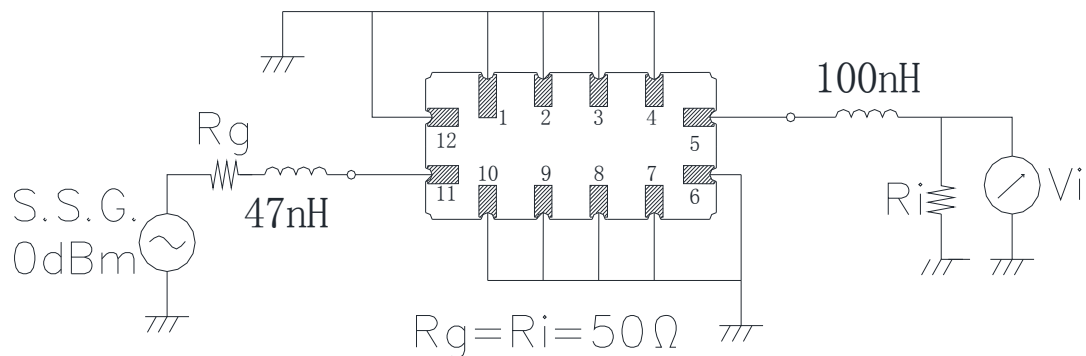

*Fig: If the products produced in 06th week of 2012, The year code & week code is 1206.

Performance**Maximum Rating**

Item		Value	Unit
DC Voltage	V _{DC}	3	V
Operation Temperature	T	-40 ~ +85	°C
Storage Temperature	T _{stg}	-55 ~ +125	°C
RF Power Dissipation	P	10	dBm

Electronic Characteristics

Test Temperature: 25°C ± 2°C

Terminating source impedance: 50Ω

Terminating load impedance: 50Ω

Item		Minimum	Typical	Maximum	Unit
Center Frequency	f _c	69.8	70.0	70.2	MHz
Insertion Loss(min)	IL		14.9	16.0	dB
Amplitude Ripple (p-p) 61.80-78.20MHz	Δα		0.7	1.0	dB
1 dB Bandwidth	BW _{1dB}	18.9	19.3		MHz
3 dB Bandwidth	BW _{3dB}	20.0	20.4		MHz
40 dB Bandwidth	BW _{40dB}		24.8	25.5	MHz
Group Delay Ripple 61.80-78.20MHz	GDR		50.0	100.0	ns
Absolute Delay 70.00MHz			1.2	1.5	us
Phase Linearity 61.80-78.20MHz			8	15	deg
Absolute Attenuation	α				
	10.00-57.00 MHz	40.0	42.0		dB
	83.00-120.00 MHz	40.0	44.0		dB

Frequency Characteristics

Frequency Response

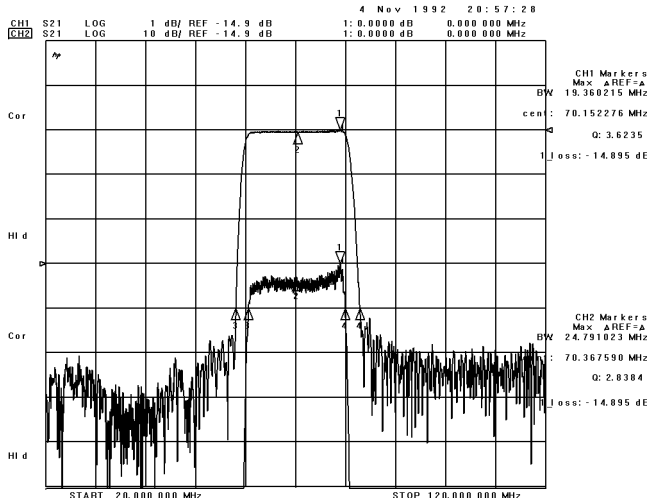

Frequency Response (wideband)

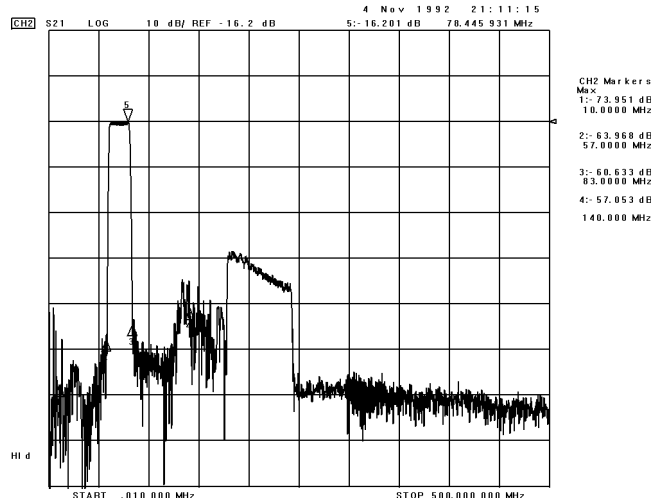

Delay Ripple

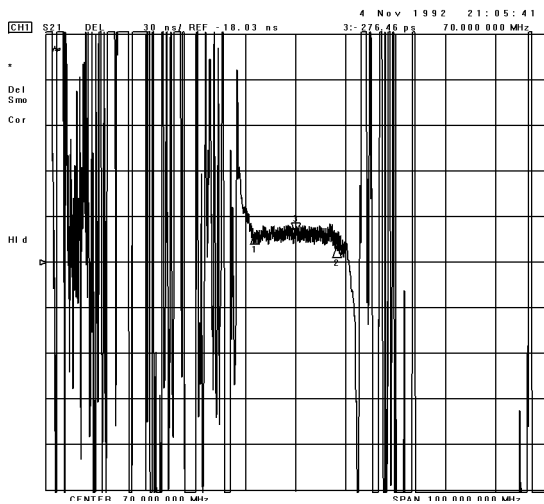

Phase Linearity

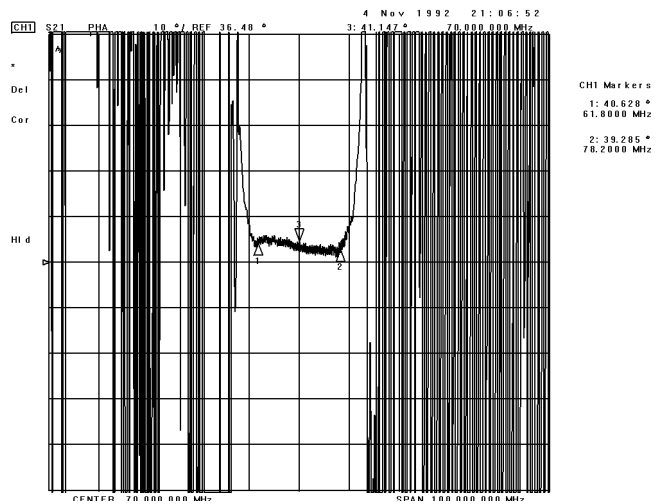

S11 Smith Chart

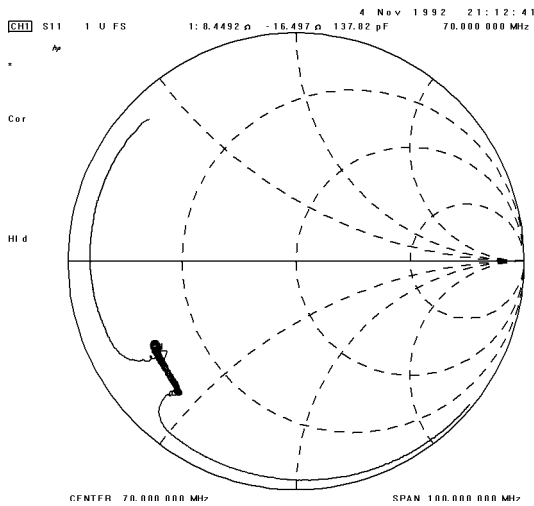

S22 Smith Chart

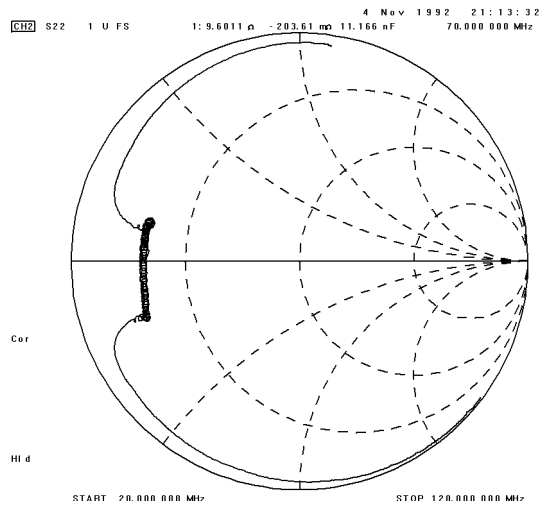

Notes

1. As a result of the particularity of inner structure of SAW products, it easy to be breakdown by electrostatic, so we should pay attention to **ESD protect** in the test.
2. **Static voltage** between signal load and ground may cause deterioration and destruction of the component. Please avoid static voltage.
3. **Ultrasonic cleaning** may cause deterioration and destruction of the component. Please avoid ultrasonic cleaning.
4. Only leads of component may **be soldered**. Please avoid soldering another part of component.
5. There is a close relationship between the device's performance and **matching network**. The specifications of this device are based on the test circuit shown above. L and C values may change depending on board layout. Values shown are intended as a guide only.