



# APPROVAL SHEET

Approval Specification	Customer's Approval Certificate
<p><b>TO:</b></p> <p><b>Part No.:</b></p> <p><b>Customer's Part No.:</b></p>	<p>Please return this copy as a certification of your approval</p> <p><b>Checked &amp; Approved by:</b></p> <p><b>Date:</b></p>

## BEIJING ZHONGXUN SIFANG SCIENCE & TECHNOLOGY CO.,LTD.

Tel: +86-010-58937383  
 Fax: +86-010-58937263  
 E-mail: [bjzxsf@bjzxsf.net](mailto:bjzxsf@bjzxsf.net)  
 Website: <http://www.bjzxsf.net>  
 Add: No 201, Block A. Building 3. Yongjie Beilu  
 Yongfeng high-tech industrial base  
 Haidian District Beijing city



Part No.	:	SF1175
Pages	:	6
Date	:	2013/3/20
Revision	:	1.0

<b>Prepared by:</b>	刘菲
<b>Checked by:</b>	
<b>Approved by:</b>	

**Application**

- Low amplitude ripple
- Sharp rejections at both out-bands
- Usable passband 1 MHz

**Features**

- RoHS compatible
- Package size 14.5x10.0x5.10mm<sup>3</sup>
- Package Code DIP1510J
- Electrostatic Sensitive Device(ESD)

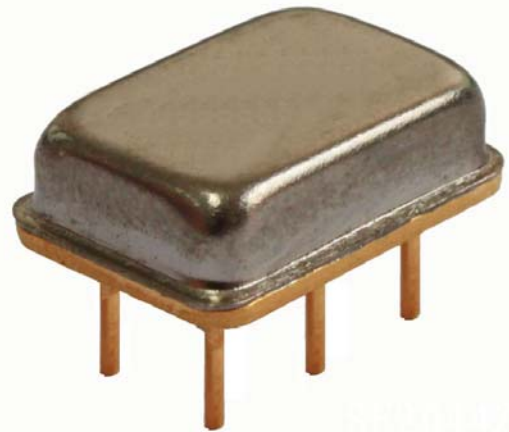

**Package Dimensions (Unit: mm)**

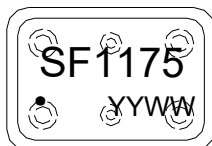
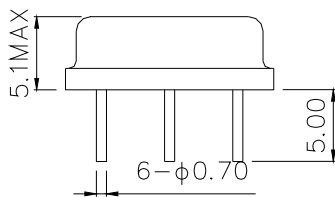
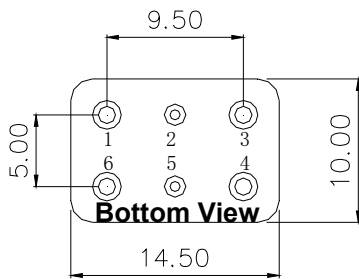

**Pin Configuration**

Pin No.	Description
6	Input
3	Output
1,2,4,5	Ground

**Marking Description**

<b>S</b>	Trademark
<b>F</b>	SAW Filter
<b>1175</b>	Part Number
<b>●</b>	Pin 1
<b>YYWW</b>	Year Code & Week Code

\*Fig: If the products produced in 06<sup>th</sup> week of 2012, The year code & week code is 1206.

**Test Circuit(Bottom View)**

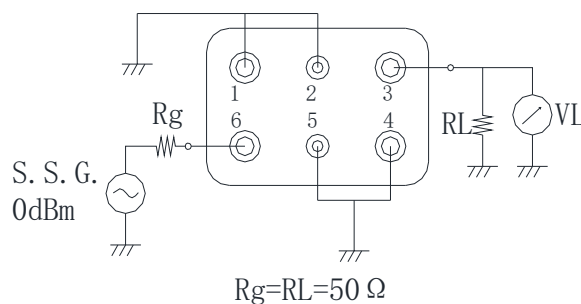

**Performance****Maximum Rating**

Item		Value	Unit
DC Voltage	$V_{DC}$	3	V
Operation Temperature	T	-40 ~ +85	°C
Storage Temperature	$T_{stg}$	-55 ~ +125	°C
RF Power Dissipation	P	10	dBm

**Electronic Characteristics**

Test Temperature:  $25^{\circ}\text{C} \pm 2^{\circ}\text{C}$

Terminating source impedance:  $50\Omega$

Terminating load impedance:  $50\Omega$

Item		Minimum	Typical	Maximum	Unit
Center Frequency	$f_c$	139.9	140.0	140.1	MHz
Insertion Loss(min)	IL		28.1	29.0	dB
Amplitude Ripple (p-p) 139.50-140.50MHz	$\Delta\alpha$		0.8	1.0	dB
1 dB Bandwidth	$BW_{1dB}$	1.5	1.6		MHz
40 dB Bandwidth	$BW_{40dB}$		2.9	3.2	MHz
Absolute Attenuation	$\alpha$				
	DC -138.00 MHz	45.0	50.0		dB
	138.50 MHz	38.0	47.0		dB
	141.50 MHz	38.0	47.0		dB
	142.00-200.00MHz	45.0	50.0		dB

Frequency Characteristics

Frequency Response

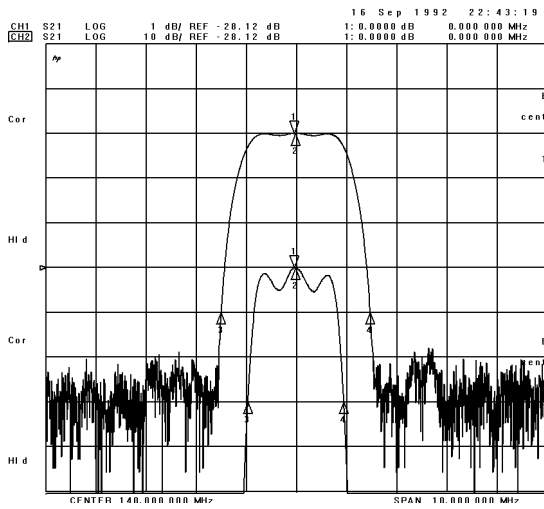

Frequency Response (wideband)

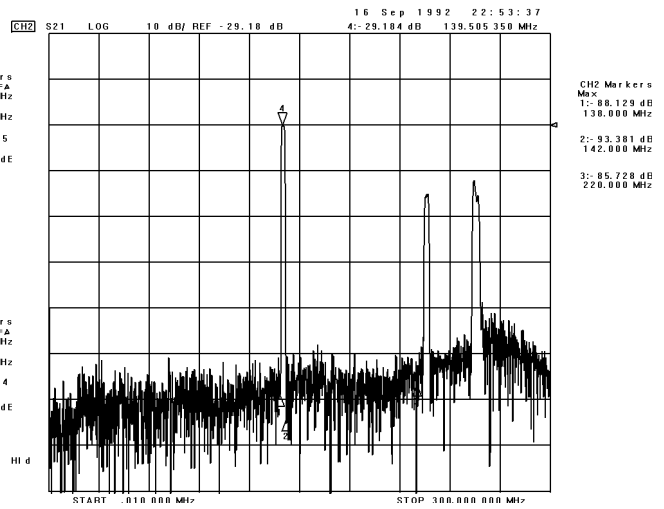

Delay Ripple

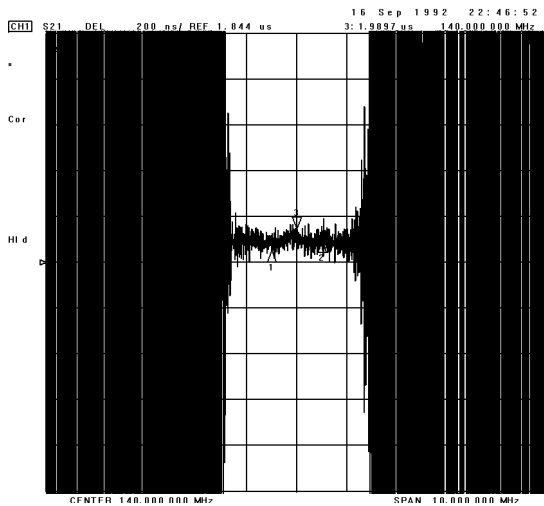

Phase Linearity

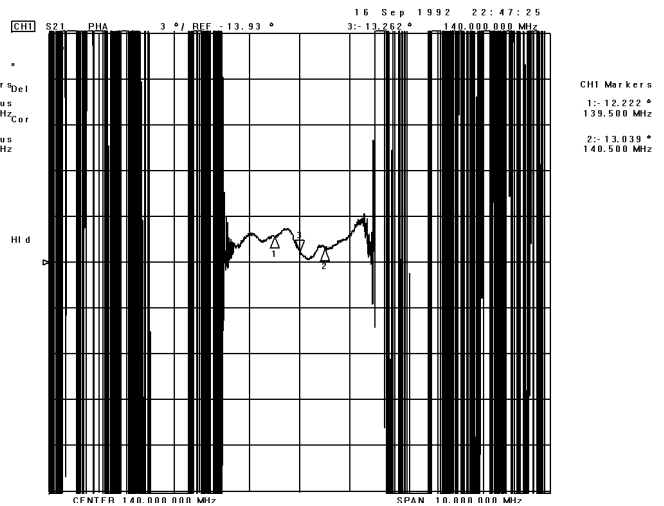

S11 Smith Chart

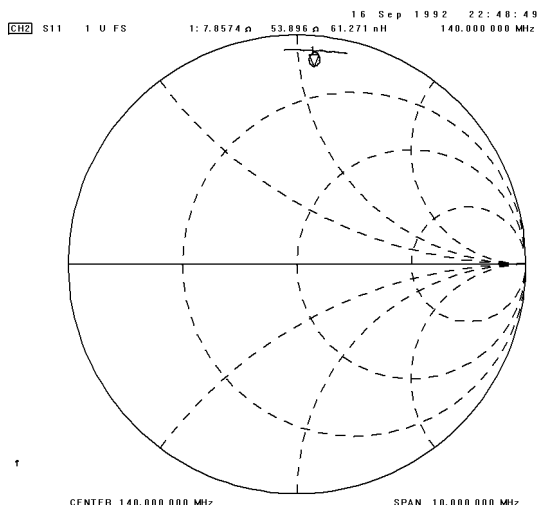

S22 Smith Chart

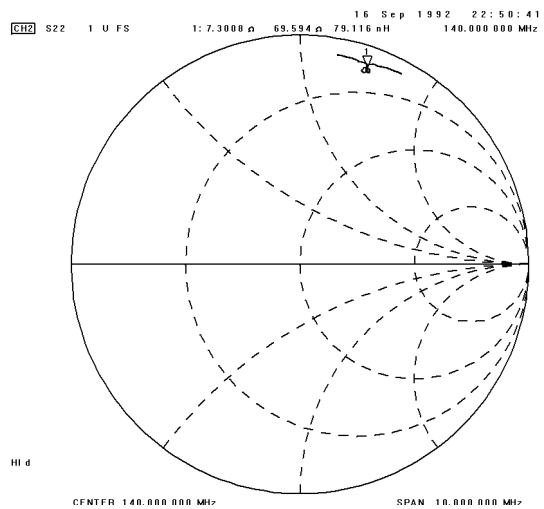

**Reliability (The SAW components shall remain electrical performance after tests)**

No.	Test item	Test condition
1	Temperature Storage	(1) Temperature: $85^{\circ}\text{C}\pm 2^{\circ}\text{C}$ , Duration: 250h , Recovery time: $2\text{h}\pm 0.5\text{h}$ (2) Temperature: $-55^{\circ}\text{C}\pm 3^{\circ}\text{C}$ , Duration: 250h ,Recovery time: $2\text{h}\pm 0.5\text{h}$
2	Humidity Test	Conditions: $60^{\circ}\text{C}\pm 2^{\circ}\text{C}$ , 90~95% RH                          Duration: 250h
3	Thermal Shock	Heat cycle conditions: TA= $-55^{\circ}\text{C}\pm 3^{\circ}\text{C}$ , TB= $85^{\circ}\text{C}\pm 2^{\circ}\text{C}$ , t1=t2=30min, Switch time: $\leq 3\text{min}$ , Cycle time: 100 times, Recovery time: $2\text{h}\pm 0.5\text{h}$ .
4	Vibration Fatigue	Frequency of vibration: 10~55Hz                          Amplitude:1.5mm Directions: X,Y and Z    Duration: 2h
5	Drop Test	Cycle time: 10 times    Height: 1.0m
6	Solder Ability Test	Temperature: $245^{\circ}\text{C}\pm 5^{\circ}\text{C}$ Duration: 3.0s--5.0s Depth: DIP--2/3 , SMD--1/5
7	Resistance to Soldering Heat	(1)Thickness of PCB:1mm , Solder condition: $260^{\circ}\text{C}\pm 5^{\circ}\text{C}$ , Duration: $10\pm 1\text{s}$ (2)Temperature of Soldering Iron: $350^{\circ}\text{C}\pm 10^{\circ}\text{C}$ , Duration: 3~4s , Recovery time : $2 \pm 0.5\text{h}$

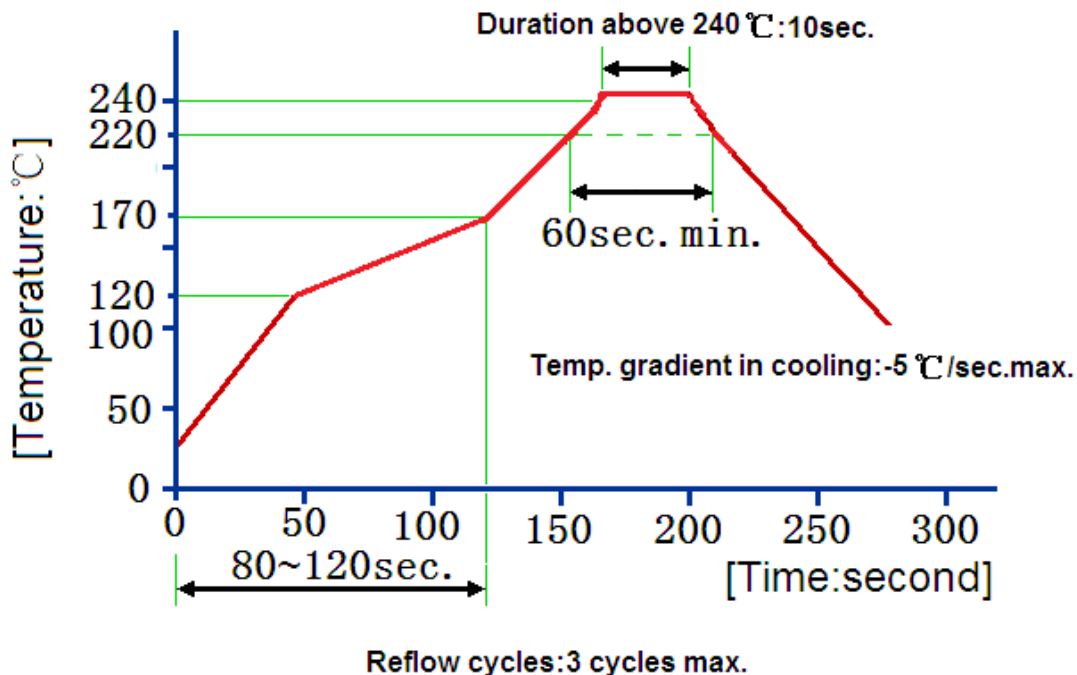
**Recommended Reflow Soldering Diagram**

**Notes**

1. As a result of the particularity of inner structure of SAW products, it easy to be breakdown by electrostatic, so we should pay attention to **ESD protect** in the test.
2. **Static voltage** between signal load and ground may cause deterioration and destruction of the component. Please avoid static voltage.
3. **Ultrasonic cleaning** may cause deterioration and destruction of the component. Please avoid ultrasonic cleaning.
4. Only leads of component may **be soldered**. Please avoid soldering another part of component.
5. There is a close relationship between the device's performance and **matching network**. The specifications of this device are based on the test circuit shown above. L and C values may change depending on board layout. Values shown are intended as a guide only.