



APPROVAL SHEET

Approval Specification	Customer's Approval Certificate
<p>TO:</p> <p>Part No.:</p> <p>Customer's Part No.:</p>	<p>Please return this copy as a certification of your approval</p> <p>Checked & Approved by:</p> <p>Date:</p>

BEIJING ZHONGXUN SIFANG SCIENCE & TECHNOLOGY CO.,LTD.

Tel: +86-010-58937383
 Fax: +86-010-58937263
 E-mail: bjzxsf@bjzxsf.net
 Website: <http://www.bjzxsf.net>
 Add: No 201, Block A. Building 3. Yongjie Beilu
 Yongfeng high-tech industrial base
 Haidian District Beijing city



Part No.	:	SF0653
Pages	:	6
Date	:	2015/12/28
Revision	:	1.0

Prepared by:	刘菲
Checked by:	
Approved by:	

Application

- Low-loss SAW component
- Low amplitude ripple
- Sharp rejections at both out-bands
- Passband 0.35~0.43MHz

Features

- RoHS compatible
- Package size 27.2x12.64x7.00mm³
- Package Code DIP2712
- Electrostatic Sensitive Device(ESD)

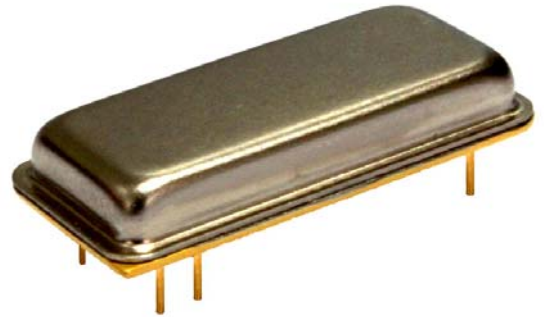

Package Dimensions (Unit: mm)

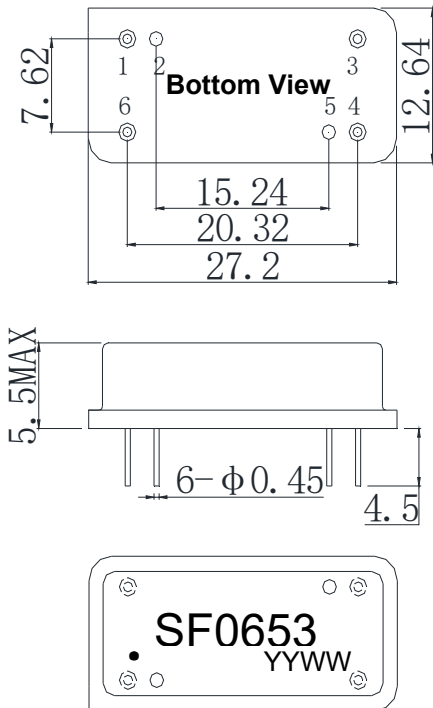

Pin Configuration

Pin No.	Description
1	Input
4	Output
2,3,5,6	Ground

Marking Description

S	Trademark
F	SAW Filter
0653	Part Number
●	Pin 1
YYWW	Year Code & Week Code

*Fig: If the products produced in 06th week of 2012, The year code & week code is 1206.

Test Circuit(Bottom View)

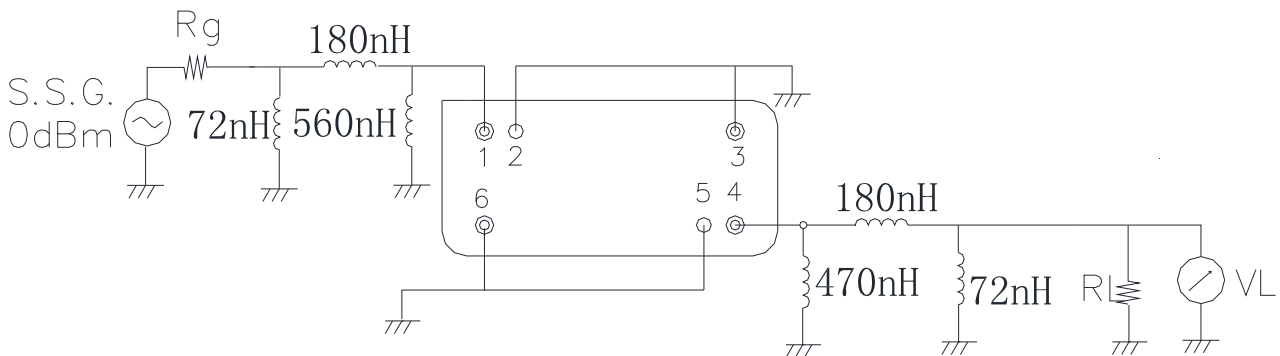

Performance**Maximum Rating**

Item		Value	Unit
DC Voltage	V_{DC}	3	V
Operation Temperature	T	-45 ~ +85	°C
Storage Temperature	T_{stg}	-55 ~ +85	°C
RF Power Dissipation	P	10	dBm

Electronic Characteristics

Test Temperature: $25^{\circ}\text{C} \pm 2^{\circ}\text{C}$

Terminating source impedance: 50Ω

Terminating load impedance: 50Ω

Item		Minimum	Typical	Maximum	Unit
Center Frequency	fc		70.00		MHz
Insertion Loss(min)	IL		9.80	10.50	dB
Amplitude Ripple (p-p)	$\Delta\alpha$		0.50	1.00	dB
1 dB Bandwidth	BW_{1dB}	0.35	0.37	0.43	MHz
Shape Factor	$\frac{BW_{40dB}}{BW_{3dB}}$		2.2	2.5	/
Absolute Attenuation	α				
	69.0MHz	50.0	55.0		dB
	71.0MHz	50.0	52.0		dB

Frequency Characteristics

Frequency Response

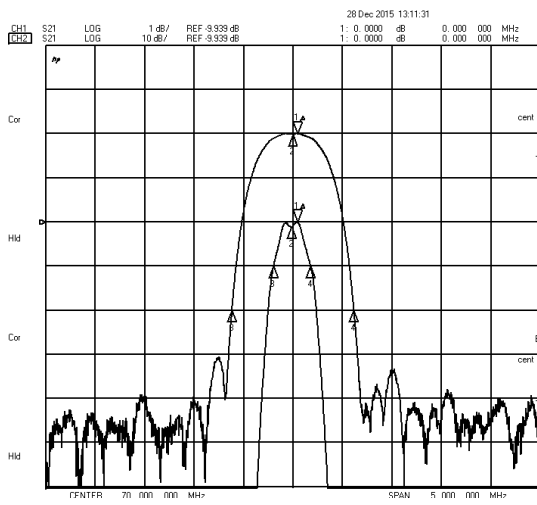

Frequency Response (wideband)

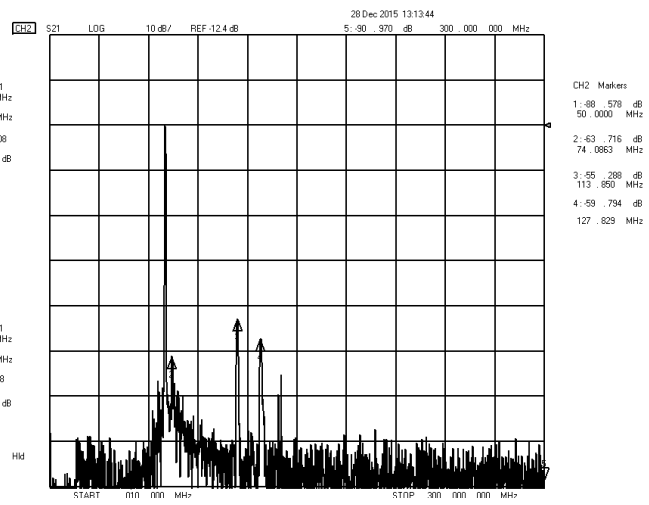

Delay Ripple & S11 VSWR

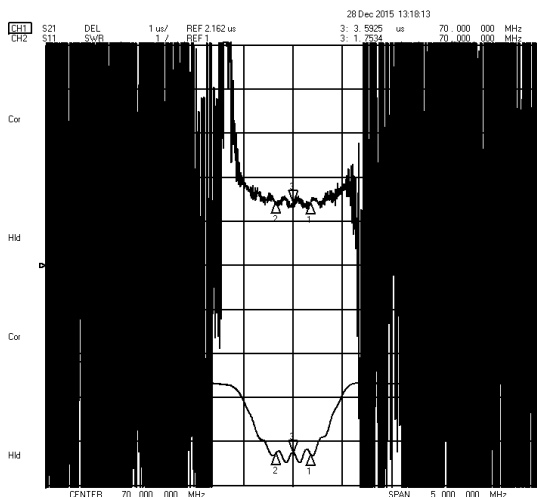

Phase Linearity & S22 VSWR

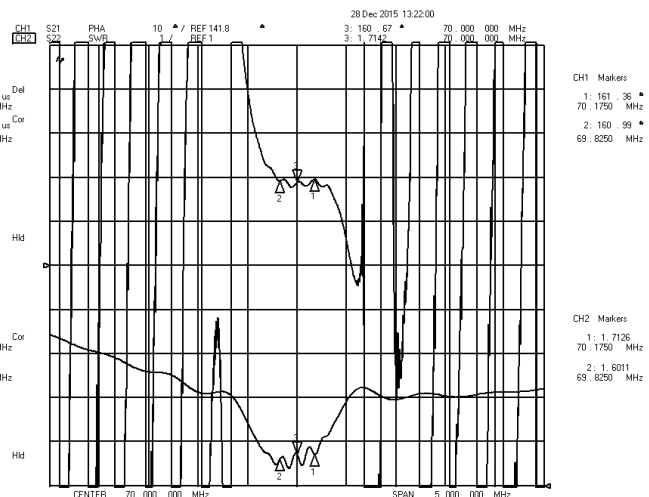

S11 Smith Chart

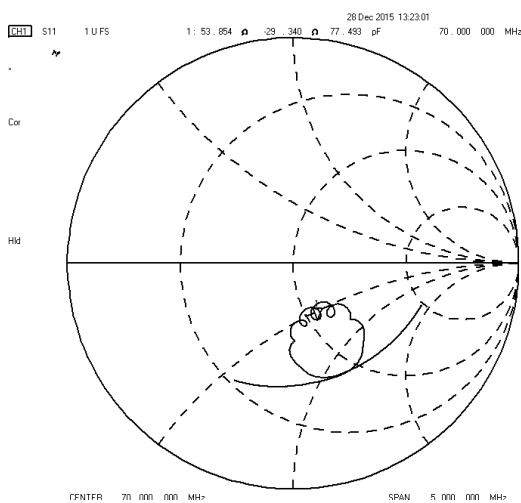

S22 Smith Chart

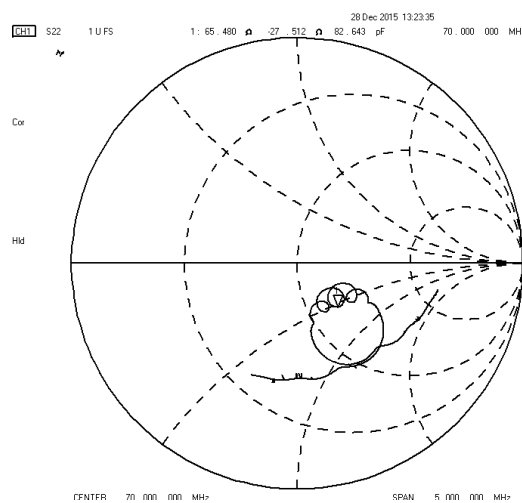

Notes

1. As a result of the particularity of inner structure of SAW products, it easy to be breakdown by electrostatic, so we should pay attention to **ESD protect** in the test.
2. **Static voltage** between signal load and ground may cause deterioration and destruction of the component. Please avoid static voltage.
3. **Ultrasonic cleaning** may cause deterioration and destruction of the component. Please avoid ultrasonic cleaning.
4. Only leads of component may **be soldered**. Please avoid soldering another part of component.
5. There is a close relationship between the device's performance and **matching network**. The specifications of this device are based on the test circuit shown above. L and C values may change depending on board layout. Values shown are intended as a guide only.