



APPROVAL SHEET

Approval Specification	Customer's Approval Certificate
<p>TO:</p> <p>Part No.:</p> <p>Customer's Part No.:</p>	<p>Please return this copy as a certification of your approval</p> <p>Checked & Approved by:</p> <p>Date:</p>

BEIJING ZHONGXUN SIFANG SCIENCE & TECHNOLOGY CO.,LTD.

Tel: +86-010-62968745
 Fax: +86-010-62973654
 E-mail: bjzxsf@bjzxsf.net
 Website: <http://www.bjzxsf.net>
 Add: NO.7 NieGeZhuang Rd,SuJiaTuo Town,
 HaiDian District,Beijing,P.R.China



Part No.	:	SF2173
Pages	:	6
Date	:	2013/2/1
Revision	:	1.0

Prepared by:	
Checked by:	
Approved by:	

Application

- Low-loss SAW component
- Low amplitude ripple
- Sharp rejections at both out-bands
- Usable passband 3 MHz

Features

- RoHS compatible
- Package size 10.9x4.45x4.00mm³
- Package Code SC04-06
- Electrostatic Sensitive Device(ESD)



Package Dimensions (Unit: mm)

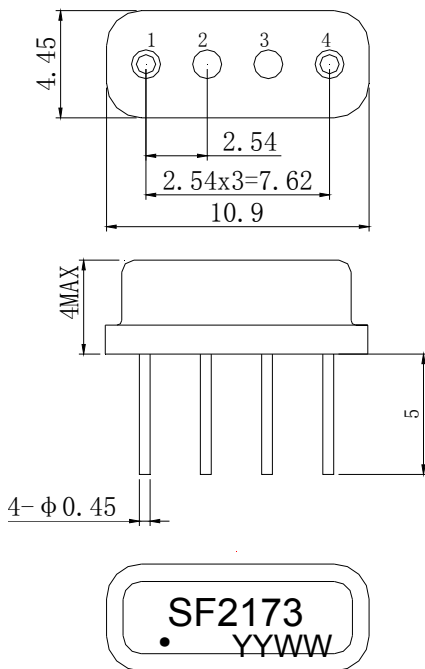

Pin Configuration

Pin No.	Description
1	Input
4	Output
2,3	Ground

Marking Description

S	Trademark
F	SAW Filter
2173	Part Number
●	Pin 1
YYWW	Year Code & Week Code

*Fig: If the products produced in 06th week of 2012, The year code & week code is 1206.

Test Circuit

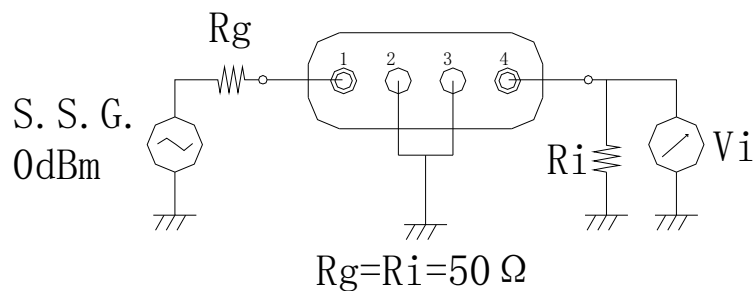

Performance**Maximum Rating**

Item		Value	Unit
DC Voltage	V _{DC}	3	V
Operation Temperature	T	-40 ~ +85	°C
Storage Temperature	T _{stg}	-55 ~ +125	°C
RF Power Dissipation	P	10	dBm

Electronic Characteristics

Test Temperature: 25°C ± 2°C

Terminating source impedance: 50Ω

Terminating load impedance: 50Ω

Item		Minimum	Typical	Maximum	Unit
Center Frequency	f _c	199.50	200.00	200.50	MHz
Insertion Loss(min)	IL		2.0	3.0	dB
Amplitude Ripple (p-p) 199.00-201.00MHz	Δα		0.8	1.0	dB
1 dB Bandwidth	BW _{1dB}	2.0	2.9		MHz
3 dB Bandwidth	BW _{3dB}	3.0	3.4		MHz
40 dB Bandwidth	BW _{40dB}		5.2	6.0	MHz
Absolute Attenuation	α				
	DC -185.00 MHz	50.0	55.0		dB
	185.00-195.00MHz	40.0	42.0		dB
	190.00 MHz	55.0	60.0		dB
	210.00 MHz	55.0	60.0		dB
	210.00-500.00 MHz	45.0	50.0		dB
Input VSWR	199.00-201.00MHz		2.0:1	2.5:1	/
Output VSWR	199.00-201.00MHz		2.0:1	2.5:1	/

Frequency Characteristics

Frequency Response

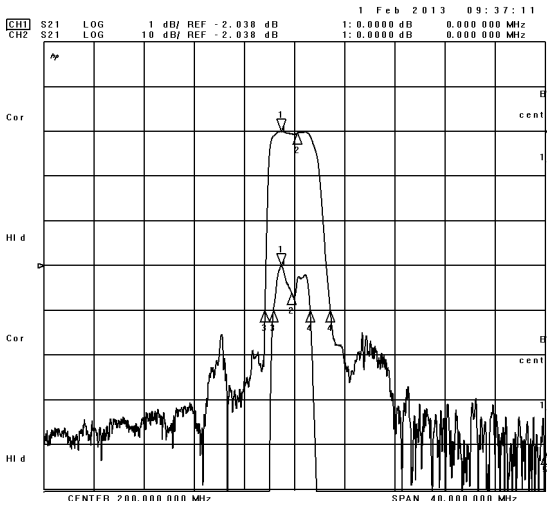

Frequency Response (wideband)

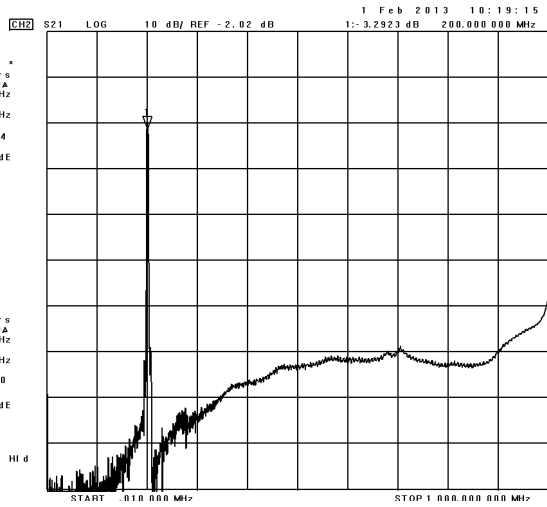

Delay Ripple & S11 VSWR

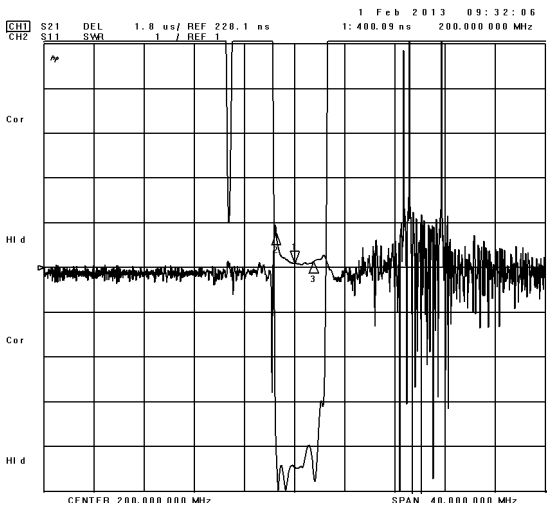

Phase Linearity & S22 VSWR

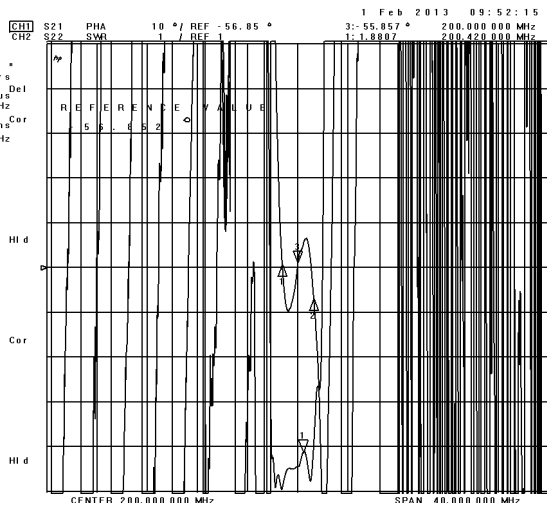

S11 Smith Chart

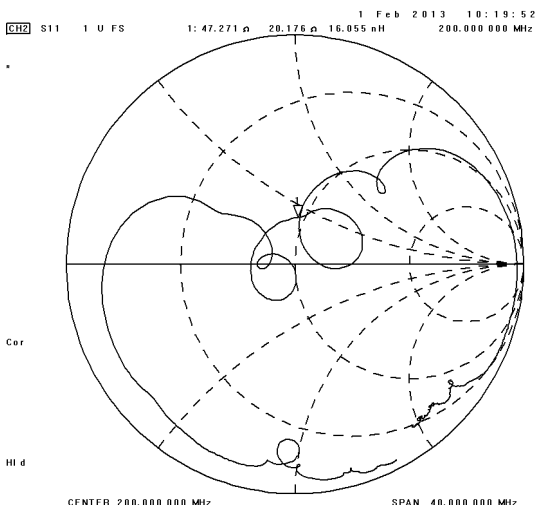

S22 Smith Chart

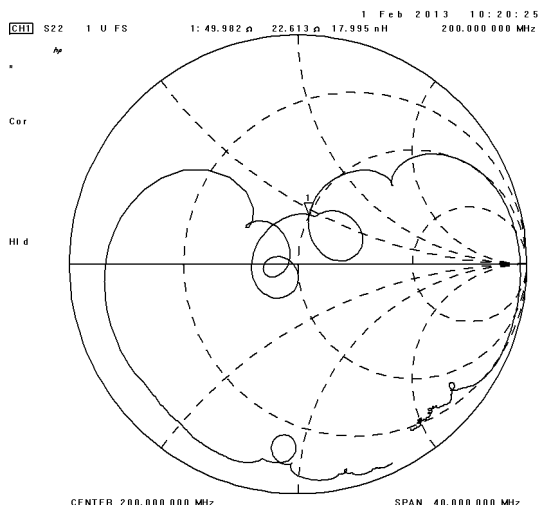

1. As a result of the particularity of inner structure of SAW products, it easy to be breakdown by electrostatic, so we should pay attention to **ESD protect** in the test.
2. **Static voltage** between signal load and ground may cause deterioration and destruction of the component. Please avoid static voltage.
3. **Ultrasonic cleaning** may cause deterioration and destruction of the component. Please avoid ultrasonic cleaning.
4. Only leads of component may **be soldered**. Please avoid soldering another part of component.
5. There is a close relationship between the device's performance and **matching network**. The specifications of this device are based on the test circuit shown above. L and C values may change depending on board layout. Values shown are intended as a guide only.