



APPROVAL SHEET

Approval Specification	Customer's Approval Certificate
<p>TO:</p> <p>Part No.:</p> <p>Customer's Part No.:</p>	<p>Please return this copy as a certification of your approval</p> <p>Checked & Approved by:</p> <p>Date:</p>

BEIJING ZHONGXUN SIFANG SCIENCE & TECHNOLOGY CO.,LTD.

Tel: +86-010-58937383
 Fax: +86-010-58937263
 E-mail: bjzxsf@bjzxsf.net
 Website: <http://www.bjzxsf.net>
 Add: No 201, Block A. Building 3. Yongjie Beilu
 Yongfeng high-tech industrial base
 Haidian District Beijing city



Part No.	:	SF0611
Pages	:	6
Date	:	2015/7/6
Revision	:	1.0

Prepared by:	梁浩
Checked by:	
Approved by:	

Application

- Low-loss SAW component
- Low amplitude ripple
- Sharp rejections at both out-bands
- Passband 2.2 MHz

Features

- Ceramic Package for **Surface Mounted Technology (SMT)**
- **RoHS** compatible
- Package size 19.00x6.50x1.75mm³
- Package Code SMD19

- **Electrostatic Sensitive Device(ESD)**

Package Dimensions (Unit: mm)

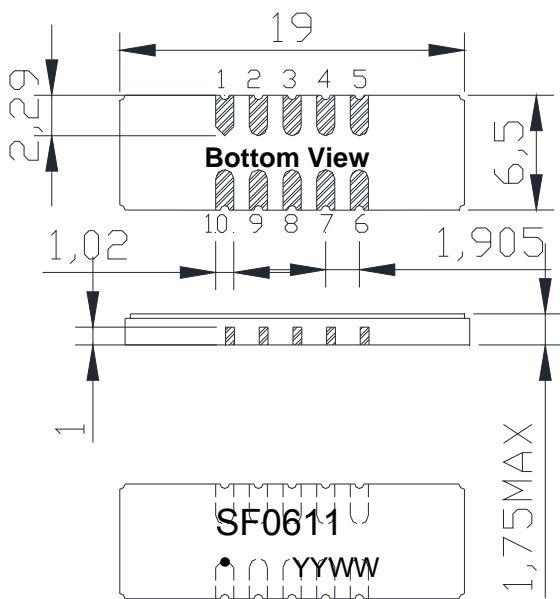

Pin Configuration

Pin No.	Description
10	Input
5	Output
1,2,3,4,6,7,8,9	Ground

Marking Description

S	Trademark
F	SAW Filter
0611	Part Number
●	Pin 1
YYWW	Year Code & Week Code

Test Circuit(Bottom View)

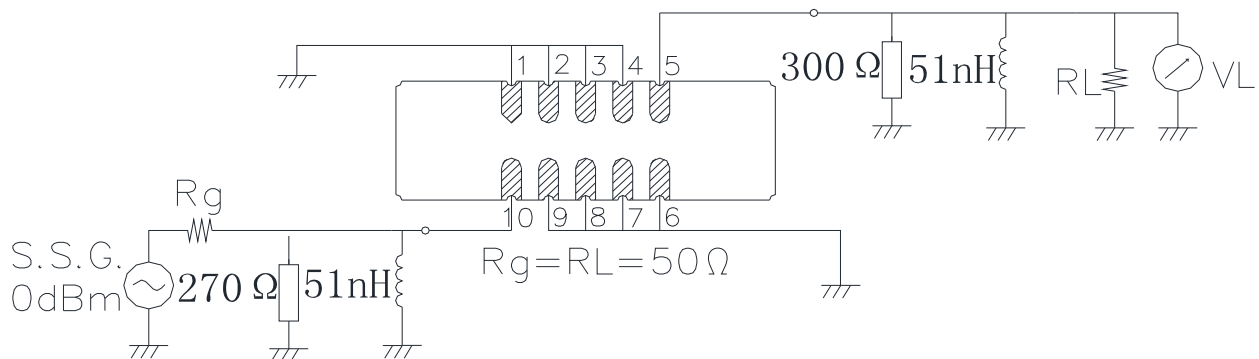

*Fig: If the products produced in 06th week of 2012, The year code & week code is 1206.

Performance**Maximum Rating**

Item		Value	Unit
DC Voltage	V _{DC}	3	V
Operation Temperature	T	-40 ~ +85	°C
Storage Temperature	T _{stg}	-55 ~ +125	°C
RF Power Dissipation	P	10	dBm

Electronic Characteristics

Test Temperature: 25°C ± 2°C

Terminating source impedance: 50Ω

Terminating load impedance: 50Ω

Item		Minimum	Typical	Maximum	Unit
Center Frequency	f _c		72.84		MHz
Insertion Loss(Fc)	IL		14.2	16.0	dB
1 dB Bandwidth(Relative to Fc)	BW _{1dB}	2.20	2.28	2.40	MHz
Absolute Attenuation(With a base of Fc)	α				
	70.94MHz	46.5	52.0		dB
	74.74MHz	46.5	49.0		dB
	62.84-70.94MHz	45.0	49.0		dB
	74.74-82.84MHz	45.0	47.0		dB
	85.00-700.00MHz	15.0	19.0		dB
Phase Linearity	71.74-73.94MHz		8.0	10.0	deg
Input VSWR	72.84MHz		1.6:1	2.5:1	/
Output VSWR	72.84MHz		1.6:1	2.0:1	/

Frequency Characteristics

Frequency Response

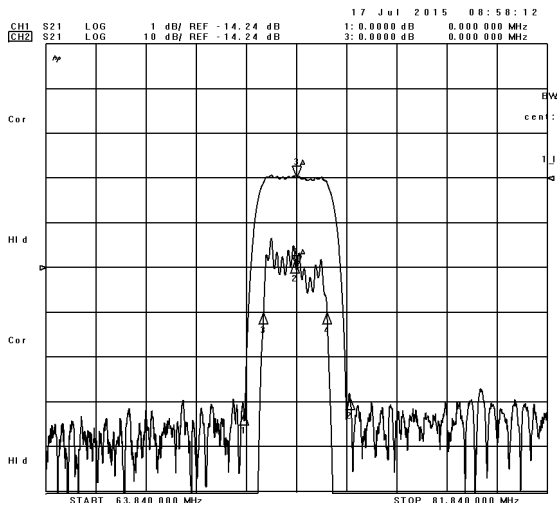

Frequency Response (wideband)

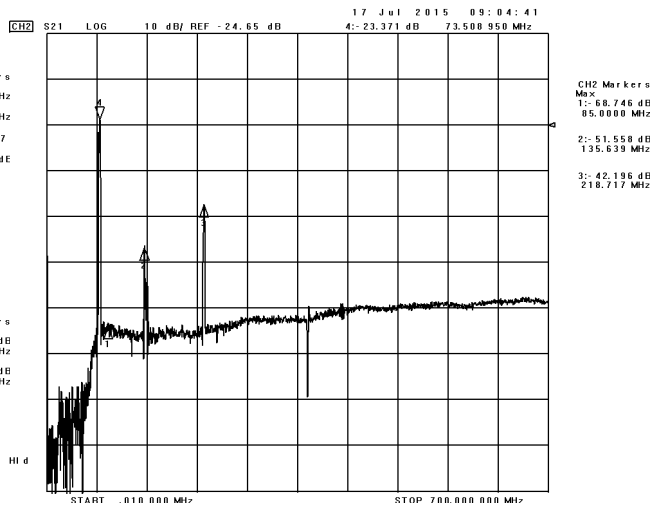

Delay Ripple & S11 VSWR

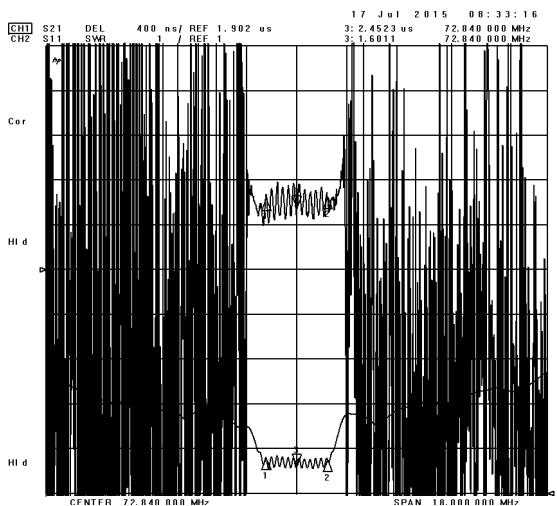

Phase Linearity & S22 VSWR

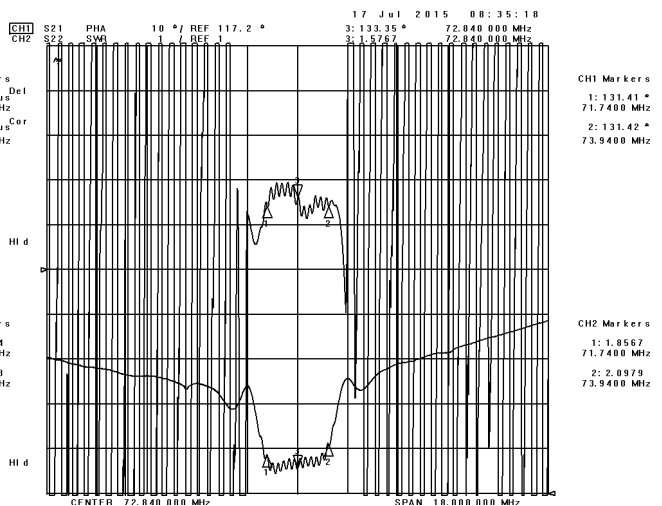

S11 Smith Chart

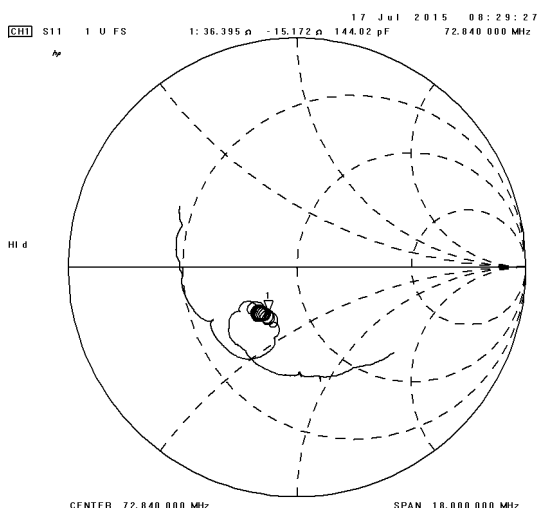

S22 Smith Chart

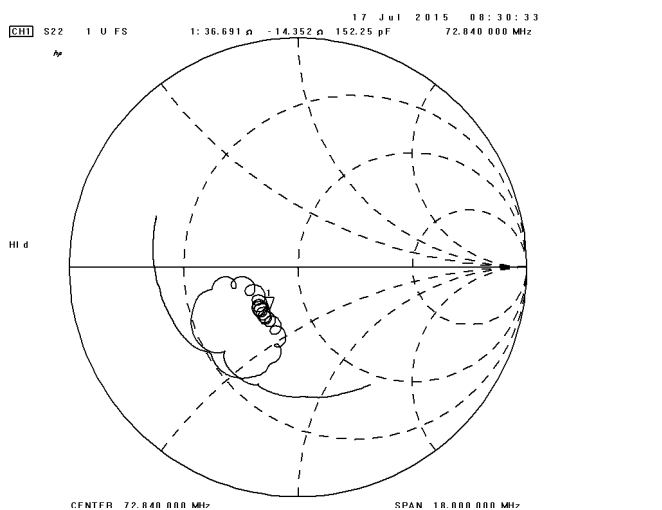

Reliability (The SAW components shall remain electrical performance after tests)

No.	Test item	Test condition
1	Temperature Storage	(1) Temperature: $85^{\circ}\text{C} \pm 2^{\circ}\text{C}$, Duration: 250h , Recovery time: $2\text{h} \pm 0.5\text{h}$ (2) Temperature: $-55^{\circ}\text{C} \pm 3^{\circ}\text{C}$, Duration: 250h , Recovery time: $2\text{h} \pm 0.5\text{h}$
2	Humidity Test	Conditions: $60^{\circ}\text{C} \pm 2^{\circ}\text{C}$, 90~95% RH Duration: 250h
3	Thermal Shock	Heat cycle conditions: $\text{TA} = -55^{\circ}\text{C} \pm 3^{\circ}\text{C}$, $\text{TB} = 85^{\circ}\text{C} \pm 2^{\circ}\text{C}$, $t_1 = t_2 = 30\text{min}$, Switch time: $\leq 3\text{min}$, Cycle time: 100 times , Recovery time: $2\text{h} \pm 0.5\text{h}$.
4	Vibration Fatigue	Frequency of vibration: 10~55Hz Amplitude: 1.5mm Directions: X,Y and Z Duration: 2h
5	Drop Test	Cycle time: 10 times Height: 1.0m
6	Solder Ability Test	Temperature: $245^{\circ}\text{C} \pm 5^{\circ}\text{C}$ Duration: 3.0s--5.0s Depth: DIP--2/3 , SMD--1/5
7	Resistance to Soldering Heat	(1) Thickness of PCB: 1mm , Solder condition: $260^{\circ}\text{C} \pm 5^{\circ}\text{C}$, Duration: $10 \pm 1\text{s}$ (2) Temperature of Soldering Iron: $350^{\circ}\text{C} \pm 10^{\circ}\text{C}$, Duration: 3~4s , Recovery time : $2 \pm 0.5\text{h}$

Recommended Reflow Soldering Diagram

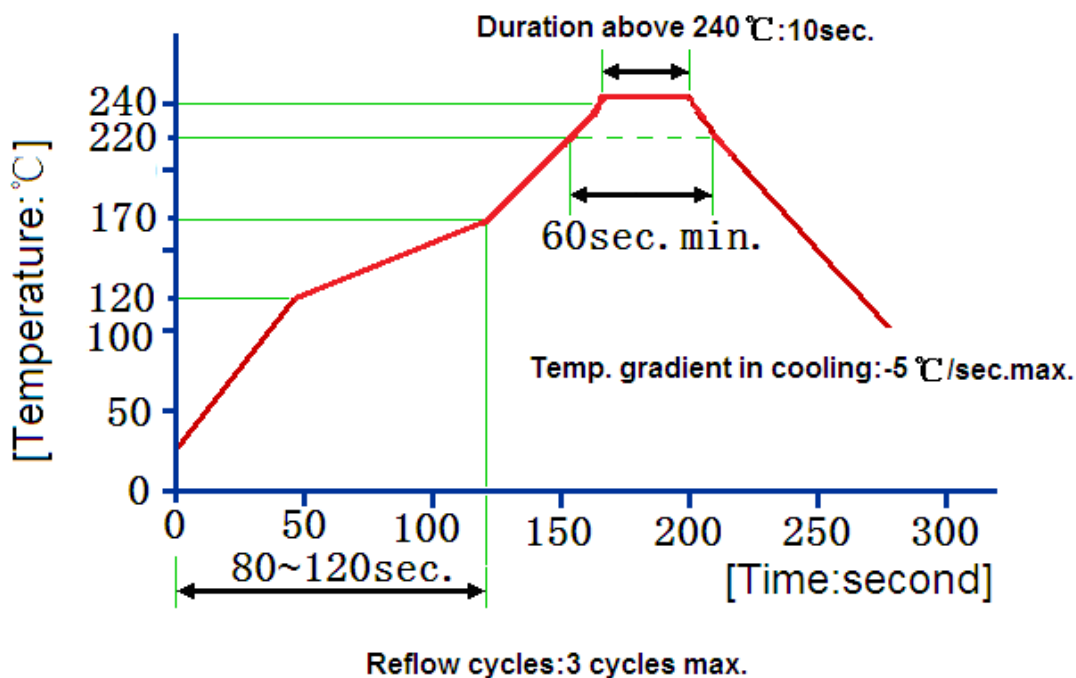

Notes

1. As a result of the particularity of inner structure of SAW products, it easy to be breakdown by electrostatic, so we should pay attention to **ESD protect** in the test.
2. **Static voltage** between signal load and ground may cause deterioration and destruction of the component. Please avoid static voltage.
3. **Ultrasonic cleaning** may cause deterioration and destruction of the component. Please avoid ultrasonic cleaning.
4. Only leads of component may **be soldered**. Please avoid soldering another part of component.
5. There is a close relationship between the device's performance and **matching network**. The specifications of this device are based on the test circuit shown above. L and C values may change depending on board layout. Values shown are intended as a guide only.