



APPROVAL SHEET

Approval Specification	Customer's Approval Certificate
<p>TO:</p> <p>Part No.:</p> <p>Customer's Part No.:</p>	<p>Please return this copy as a certification of your approval</p> <p>Checked & Approved by:</p> <p>Date:</p>

BEIJING ZHONGXUN SIFANG SCIENCE & TECHNOLOGY CO.,LTD.

Tel: +86-010-58937383
 Fax: +86-010-58937263
 E-mail: bjzxsf@bjzxsf.net
 Website: <http://www.bjzxsf.net>
 Add: No 201, Block A. Building 3. Yongjie Beilu
 Yongfeng high-tech industrial base
 Haidian District Beijing city



Part No.	:	SF1543
Pages	:	6
Date	:	2015/8/31
Revision	:	1.0

Prepared by:	梁浩
Checked by:	
Approved by:	

Application

- Low -loss SAW component
- Low amplitude ripple
- Sharp rejections at both out-bands
- Passband 20.5 MHz

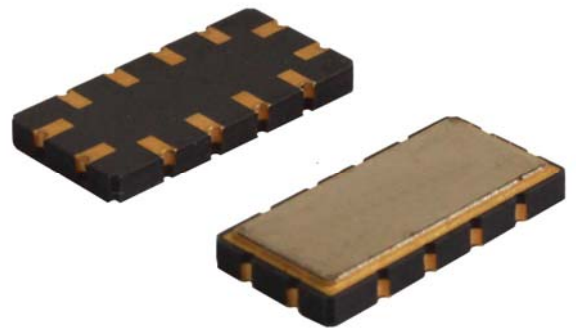

Features

- Ceramic Package for **Surface Mounted Technology (SMT)**
- **RoHS** compatible
- Package size 13.30x6.50x1.80mm³
- Package Code QCC12
- **Electrostatic Sensitive Device(ESD)**

Package Dimensions (Unit: mm)

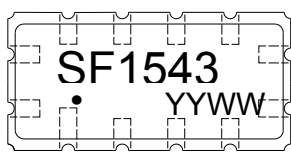
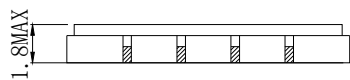
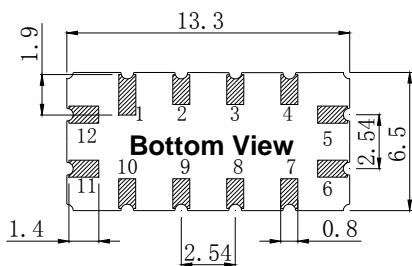

Pin Configuration

Pin No.	Description
11	Input
5	Output
1,2,3,4,6,7,8,9,10,12	Ground

Marking Description

S	Trademark
F	SAW Filter
1543	Part Number
●	Pin 1
YYWW	Year Code & Week Code

*Fig: If the products produced in 06th week of 2012, The year code & week code is 1206.

Test Circuit(Bottom View)

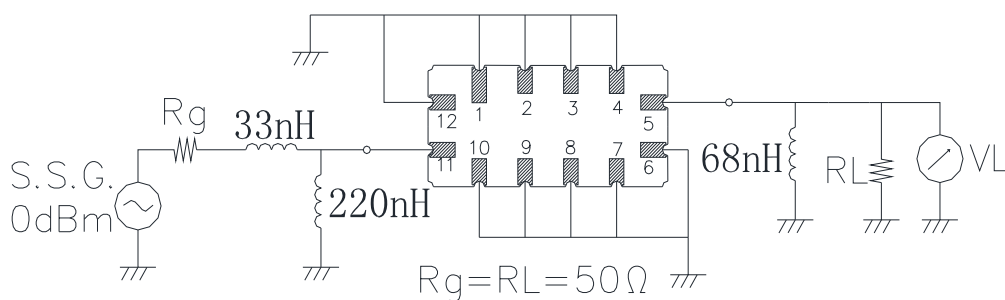

Performance**Maximum Rating**

Item		Value	Unit
DC Voltage	V_{DC}	3	V
Operation Temperature	T	-40 ~ +85	°C
Storage Temperature	T_{stg}	-55 ~ +125	°C
RF Power Dissipation	P	10	dBm

Electronic Characteristics

Test Temperature: $25^{\circ}\text{C} \pm 2^{\circ}\text{C}$

Terminating source impedance: 50Ω

Terminating load impedance: 50Ω

Item		Minimum	Typical	Maximum	Unit
Center Frequency	fc		150.0		MHz
Insertion Loss(min)	IL		10.0	20.0	dB
Amplitude Ripple	$\Delta\alpha$		0.5	1.0	dB
1 dB Bandwidth	BW_{1dB}	20.5	21.3		MHz
3 dB Bandwidth	BW_{3dB}		23.8	24.0	MHz
40 dB Bandwidth	BW_{40dB}		33.2	34.0	MHz
Absolute Delay	AD		0.5	1.0	us

Frequency Characteristics

Frequency Response

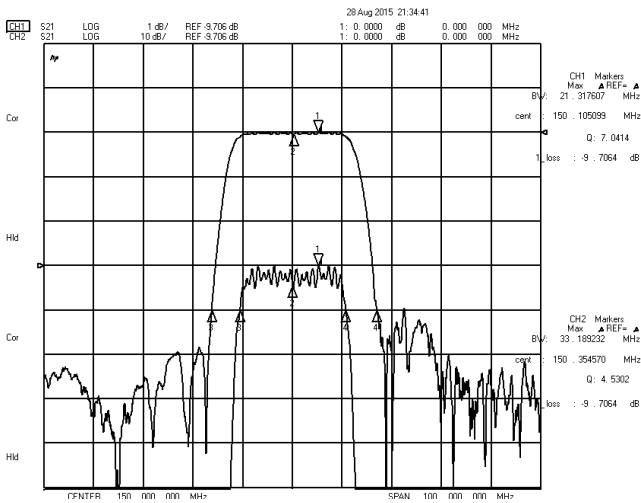

Frequency Response (wideband)

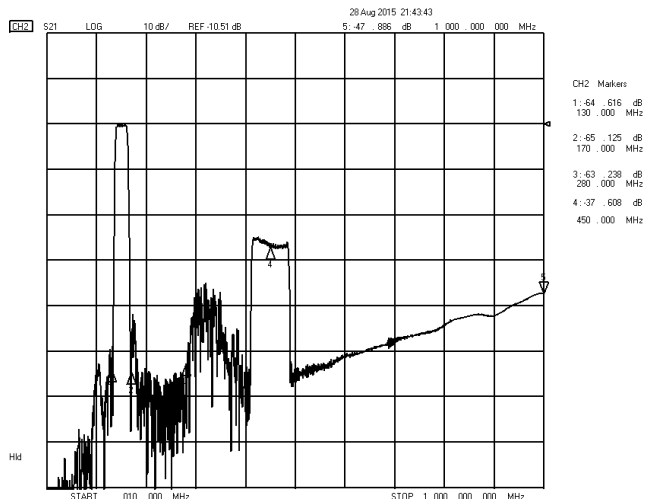

Delay Ripple & S11 VSWR

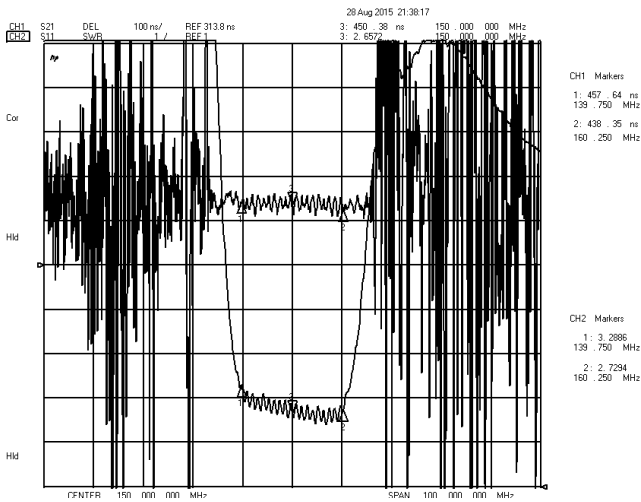

Phase Linearity & S22 VSWR

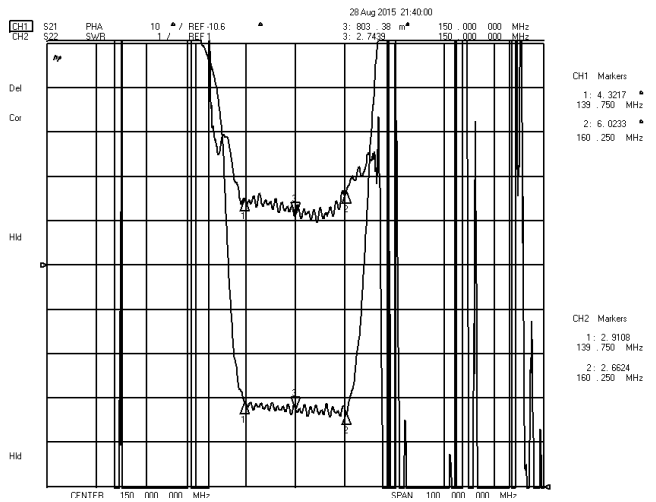

S11 Smith Chart

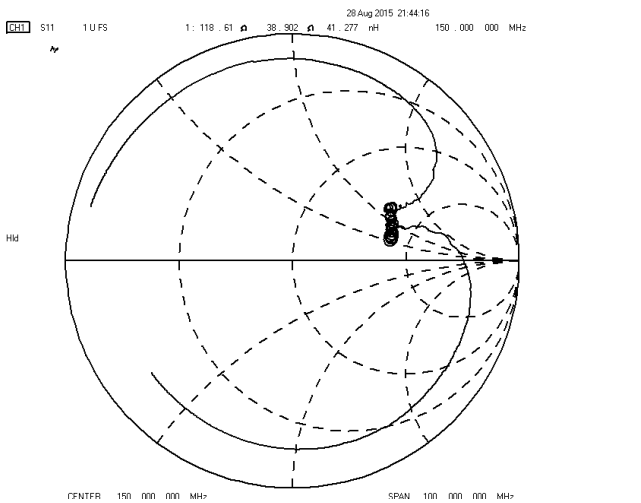

S22 Smith Chart

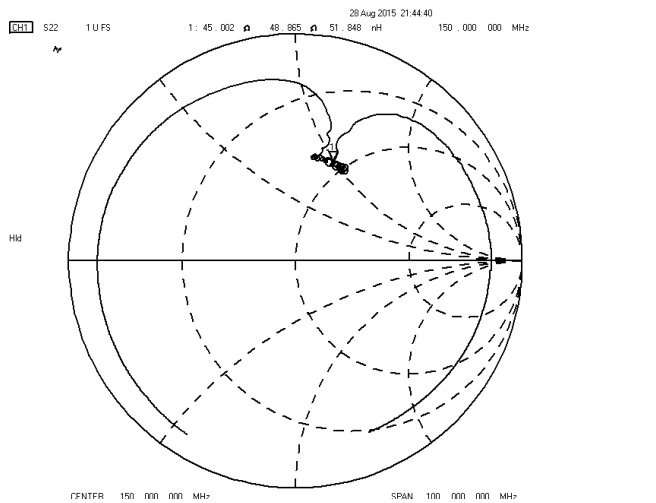

Notes

1. As a result of the particularity of inner structure of SAW products, it easy to be breakdown by electrostatic, so we should pay attention to **ESD protect** in the test.
2. **Static voltage** between signal load and ground may cause deterioration and destruction of the component. Please avoid static voltage.
3. **Ultrasonic cleaning** may cause deterioration and destruction of the component. Please avoid ultrasonic cleaning.
4. Only leads of component may **be soldered**. Please avoid soldering another part of component.
5. There is a close relationship between the device's performance and **matching network**. The specifications of this device are based on the test circuit shown above. L and C values may change depending on board layout. Values shown are intended as a guide only.