



APPROVAL SHEET

Approval Specification	Customer's Approval Certificate
TO:	Please return this copy as a certification of your approval
Part No.:	Checked & Approved by:
Customer's Part No.:	Date:

BEIJING ZHONGXUN SIFANG SCIENCE & TECHNOLOGY CO.,LTD.

Tel: +86-010-58937383
Fax: +86-010-58937263
E-mail: bjzxsf@bjzxsf.net
Website: <http://www.bjzxsf.net>
Add: No 201, Block A. Building 3. Yongjie Beilu
Yongfeng high-tech industrial base
Haidian District Beijing city



Part No.	:	SF2506
Pages	:	6
Date	:	2016/6/13
Revision	:	1.0

Prepared by:	刘菲
Checked by:	
Approved by:	

Application

- Low -loss SAW component
- Low amplitude ripple
- Sharp rejections at both out-bands
- Passband 0.10 MHz

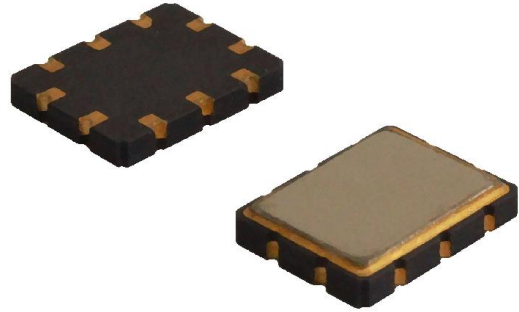

Features

- Ceramic Package for **Surface Mounted Technology (SMT)**
- **RoHS** compatible
- Package size 7.00x5.00x1.60mm³
- Package Code QCC12C
- **Electrostatic Sensitive Device(ESD)**

Package Dimensions (Unit: mm)

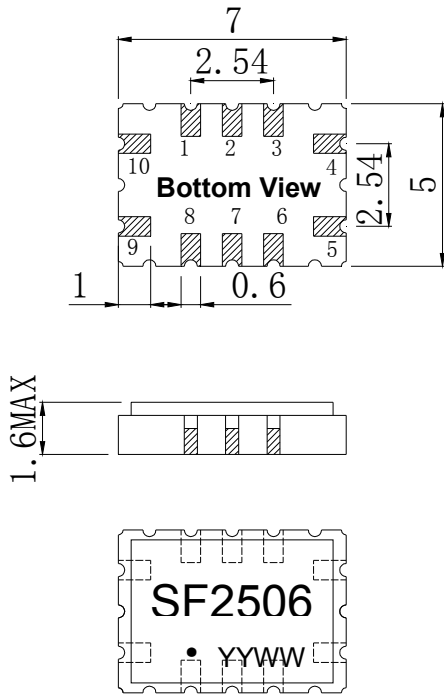

Pin Configuration

Pin No.	Description
9	Input
4	Output
1,2,3,5,6,7,8,10	Ground

Marking Description

S	Trademark
F	SAW Filter
2506	Part Number
●	Pin 1
YYWW	Year Code & Week Code

*Fig: If the products produced in 06th week of 2012,
The year code & week code is 1206.

Test Circuit(Bottom View)

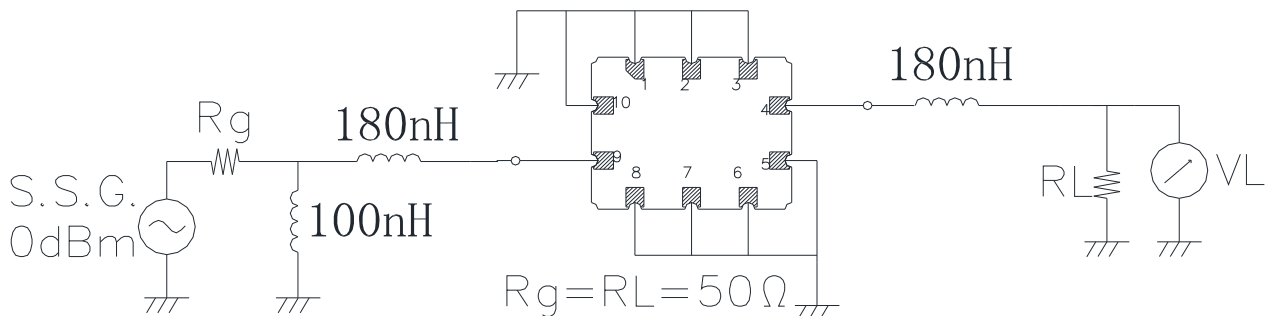

Performance**Maximum Rating**

Item		Value	Unit
DC Voltage	V_{DC}	3	V
Operation Temperature	T	-40 ~ +85	°C
Storage Temperature	T_{stg}	-55 ~ +85	°C
RF Power Dissipation	P	10	dBm

Electronic Characteristics

Test Temperature: $25^{\circ}\text{C} \pm 2^{\circ}\text{C}$

Terminating source impedance: 50Ω

Terminating load impedance: 50Ω

Item		Minimum	Typical	Maximum	Unit
Center Frequency	f_c		240.0		MHz
Insertion Loss @Fc	IL		5.0	5.5	dB
Amplitude Ripple	$\Delta\alpha$		0.3	1.0	dB
3 dB Bandwidth	BW_{3dB}	0.10	0.18		MHz
Absolute Attenuation	α				
	DC-239.5MHz	20.0	50.0		dB
	240.5-480.0MHz	20.0	50.0		dB
Input VSWR	239.95-240.05MHz		2.5:1	3.5:1	/
Output VSWR	239.95-240.05MHz		2.5:1	3.5:1	/

Frequency Characteristics

Frequency Response

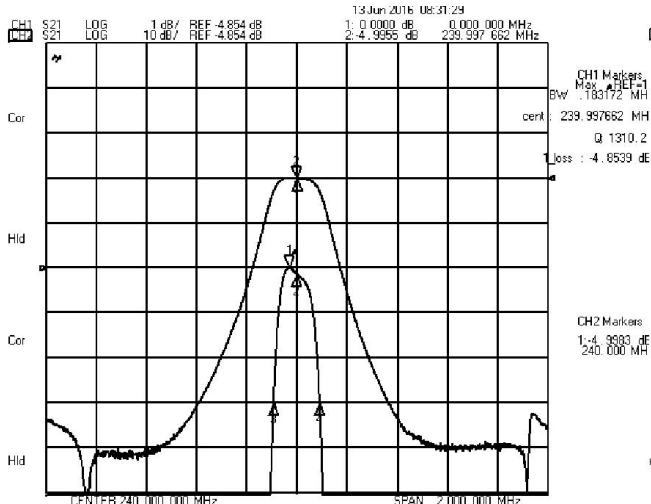

Frequency Response (wideband)

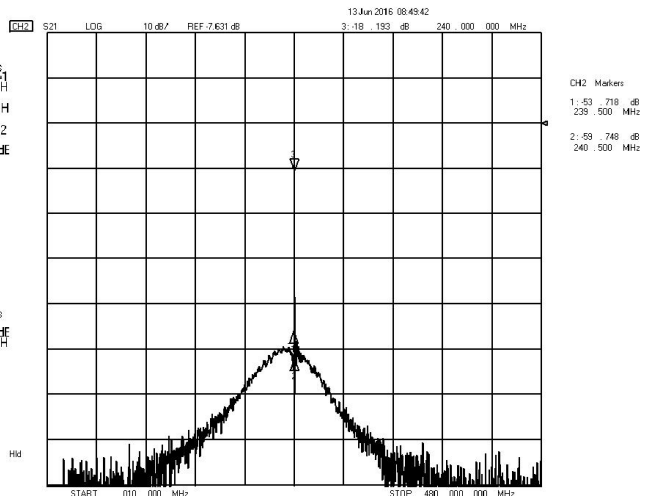

Delay Ripple & S11 VSWR

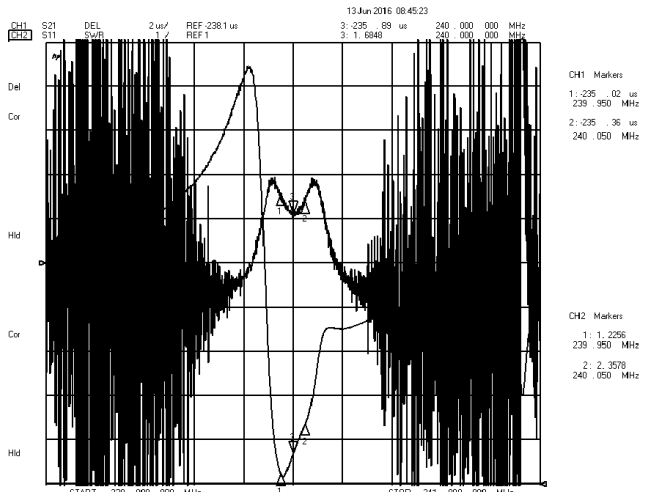

Phase Linearity & S22 VSWR

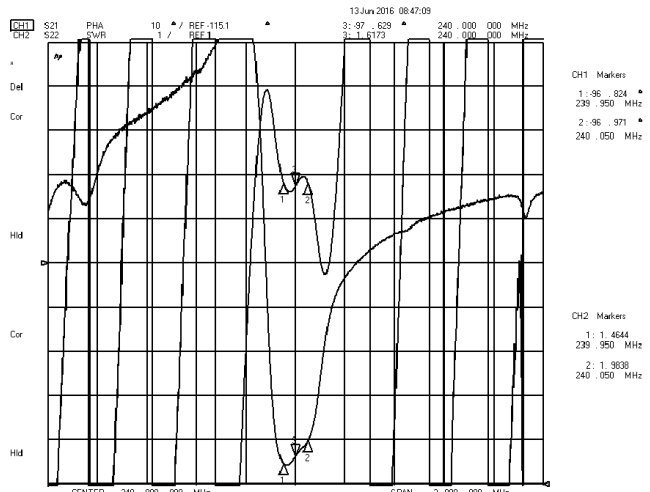

S11 Smith Chart

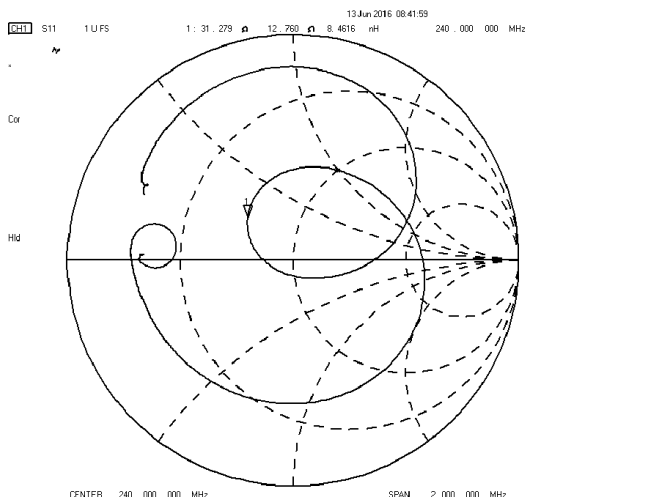

S22 Smith Chart

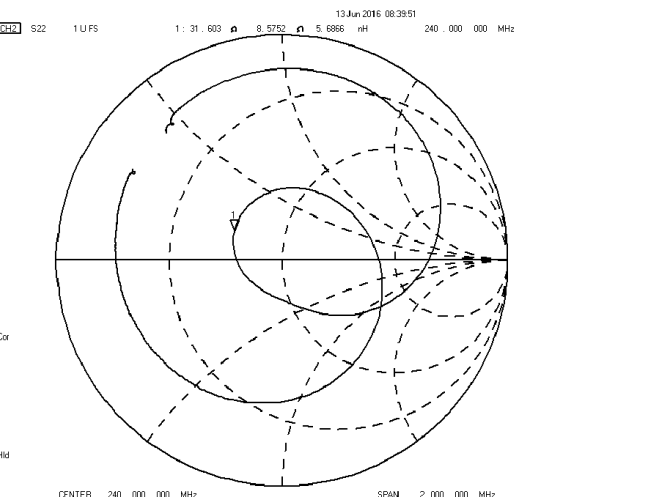

Notes

1. As a result of the particularity of inner structure of SAW products, it easy to be breakdown by electrostatic, so we should pay attention to **ESD protect** in the test.
2. **Static voltage** between signal load and ground may cause deterioration and destruction of the component. Please avoid static voltage.
3. **Ultrasonic cleaning** may cause deterioration and destruction of the component. Please avoid ultrasonic cleaning.
4. Only leads of component may **be soldered**. Please avoid soldering another part of component.
5. There is a close relationship between the device's performance and **matching network**. The specifications of this device are based on the test circuit shown above. L and C values may change depending on board layout. Values shown are intended as a guide only.