



# APPROVAL SHEET

Approval Specification	Customer's Approval Certificate
<b>TO:</b>	Please return this copy as a certification of your approval
<b>Part No.:</b>	<b>Checked &amp; Approved by:</b>
<b>Customer's Part No.:</b>	<b>Date:</b>

## BEIJING ZHONGXUN SIFANG SCIENCE & TECHNOLOGY CO.,LTD.

Tel: +86-010-58937383  
Fax: +86-010-58937263  
E-mail: [bjzxsf@bjzxsf.net](mailto:bjzxsf@bjzxsf.net)  
Website: <http://www.bjzxsf.net>  
Add: No 201, Block A. Building 3. Yongjie Beilu  
Yongfeng high-tech industrial base  
Haidian District Beijing city



Part No.	:	SF1606
Pages	:	6
Date	:	2016/10/25
Revision	:	1.0

<b>Prepared by:</b>	刘建伟
<b>Checked by:</b>	卢翠
<b>Approved by:</b>	张健

**Application**

- Low -loss SAW component
- Low amplitude ripple
- Sharp rejections at both out-bands
- Passband 0.675 MHz

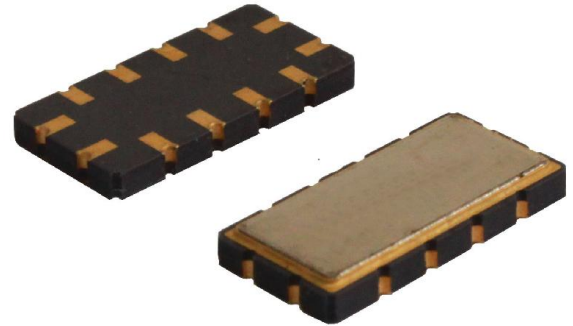

**Features**

- Ceramic Package for **Surface Mounted Technology (SMT)**
- **RoHS** compatible
- Package size 13.30x6.50x1.80mm<sup>3</sup>
- Package Code QCC12
- **Electrostatic Sensitive Device(ESD)**

**Package Dimensions (Unit: mm)**

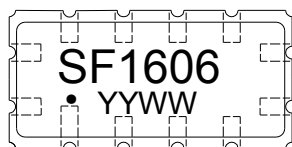
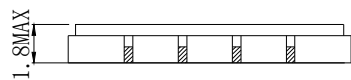
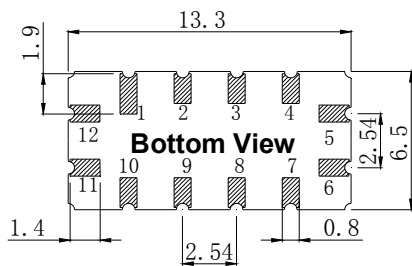

**Pin Configuration**

Pin No.	Description
11	Input
5	Output
1,2,3,4,6,7,8,9,10,12	Ground

**Marking Description**

<b>S</b>	Trademark
<b>F</b>	SAW Filter
<b>1606</b>	Part Number
●	Pin 1
<b>YYWW</b>	Year Code & Week Code

**Test Circuit(Bottom View)**

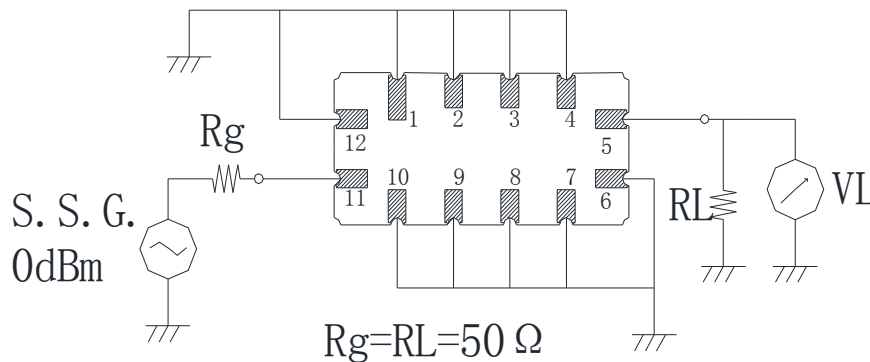

\*Fig: If the products produced in 06<sup>th</sup> week of 2012,  
The year code & week code is 1206.

**Performance****Maximum Rating**

Item		Value	Unit
DC Voltage	V <sub>DC</sub>	3	V
Operation Temperature	T	-55 ~ +85	°C
Storage Temperature	T <sub>stg</sub>	-65 ~ +100	°C
RF Power Dissipation	P	10	dBm

**Electronic Characteristics**

Test Temperature: 25°C ± 2°C

Terminating source impedance: 50Ω

Terminating load impedance: 50Ω

Item		Minimum	Typical	Maximum	Unit
Center Frequency	f <sub>c</sub>		108.00		MHz
Insertion Loss(min)	IL		3.2	4.0	dB
Amplitude Ripple (p-p) 107.766-108.311 MHz	Δα		0.6	1.0	dB
3 dB Bandwidth	BW <sub>3dB</sub>	0.675	0.915		MHz
Absolute Attenuation	α				
	DC-106.50MHz	45	51		dB
	109.50 -240.00MHz	45	51		dB
Input VSWR	107.766-108.311 MHz		2.1:1	2.5:1	/
Output VSWR	107.766-108.311 MHz		2.1:1	2.5:1	/

Frequency Characteristics

Frequency Response

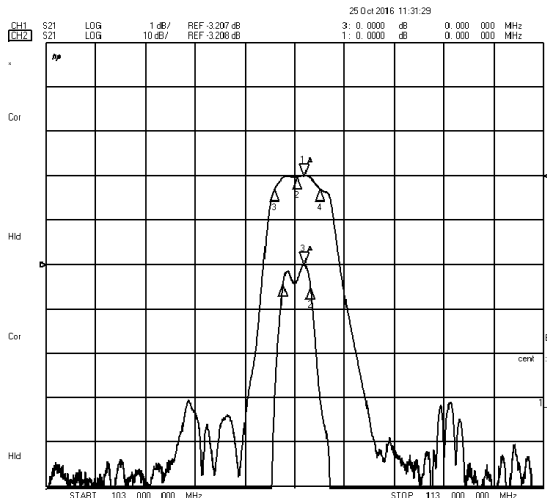

Frequency Response (wideband)

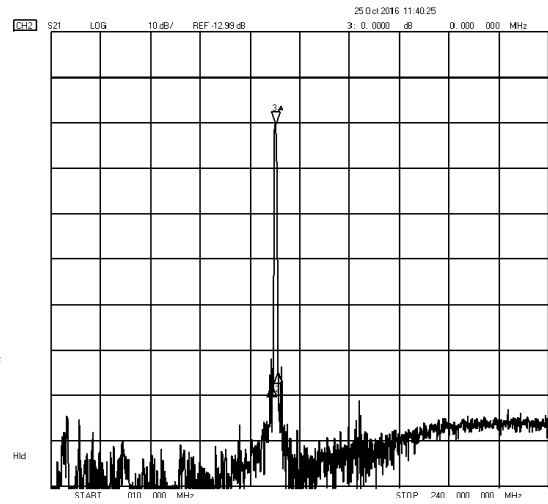

Delay Ripple & S11 VSWR

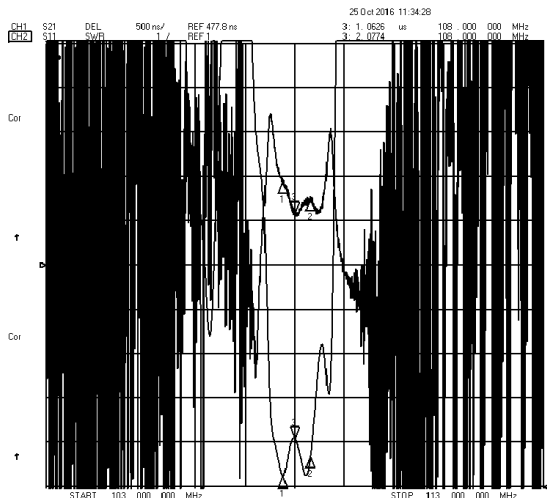

Phase Linearity & S22 VSWR

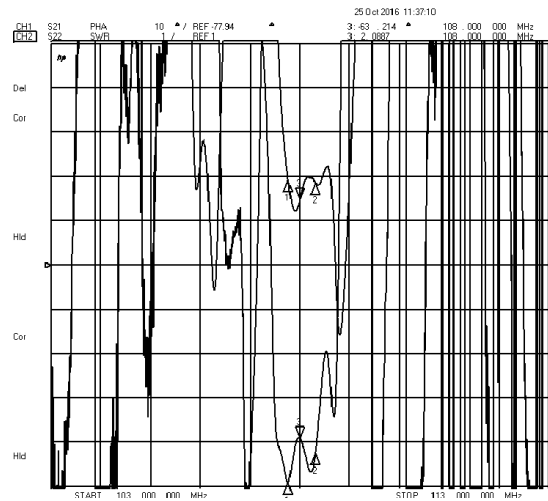

S11 Smith Chart

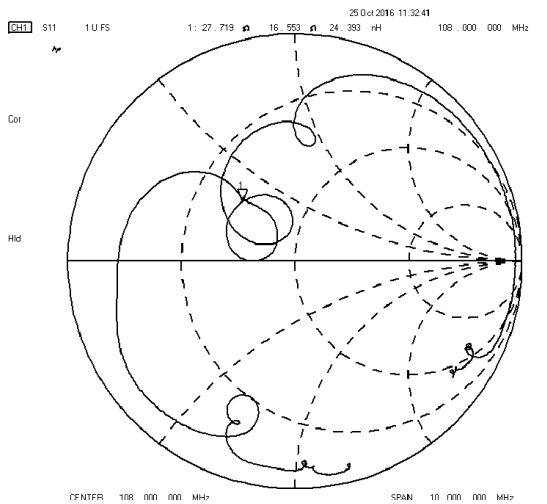

S22 Smith Chart

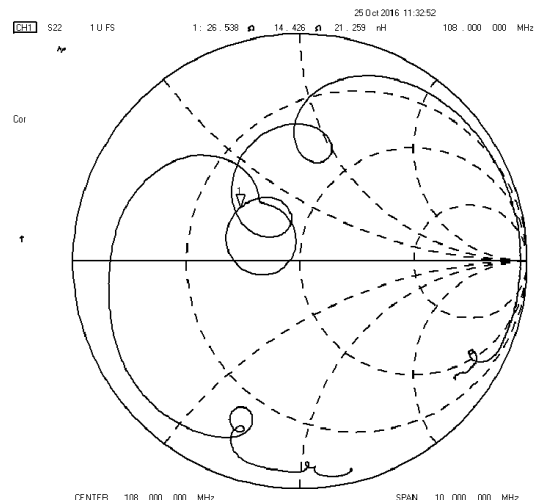

**Reliability (The SAW components shall remain electrical performance after tests)**

No.	Test item	Test condition
1	Temperature Storage	(1) Temperature: $85^{\circ}\text{C}\pm 2^{\circ}\text{C}$ , Duration: 250h , Recovery time: $2\text{h}\pm 0.5\text{h}$ (2) Temperature: $-55^{\circ}\text{C}\pm 3^{\circ}\text{C}$ , Duration: 250h ,Recovery time: $2\text{h}\pm 0.5\text{h}$
2	Humidity Test	Conditions: $60^{\circ}\text{C}\pm 2^{\circ}\text{C}$ , 90~95% RH          Duration: 250h
3	Thermal Shock	Heat cycle conditions: $\text{TA}=-55^{\circ}\text{C}\pm 3^{\circ}\text{C}$ , $\text{TB}=85^{\circ}\text{C}\pm 2^{\circ}\text{C}$ , $t_1=t_2=30\text{min}$ , Switch time: $\leq 3\text{min}$ , Cycle time: 100 times, Recovery time: $2\text{h}\pm 0.5\text{h}$ .
4	Vibration Fatigue	Frequency of vibration: 10~55Hz          Amplitude:1.5mm Directions: X,Y and Z          Duration: 2h
5	Drop Test	Cycle time: 10 times          Height: 1.0m
6	Solder Ability Test	Temperature: $245^{\circ}\text{C}\pm 5^{\circ}\text{C}$ Duration: 3.0s--5.0s Depth: DIP--2/3 , SMD--1/5
7	Resistance to Soldering Heat	(1)Thickness of PCB:1mm , Solder condition: $260^{\circ}\text{C}\pm 5^{\circ}\text{C}$ , Duration: $10\pm 1\text{s}$ (2)Temperature of Soldering Iron: $350^{\circ}\text{C}\pm 10^{\circ}\text{C}$ , Duration: 3~4s , Recovery time : $2 \pm 0.5\text{h}$

**Recommended Reflow Soldering Diagram**

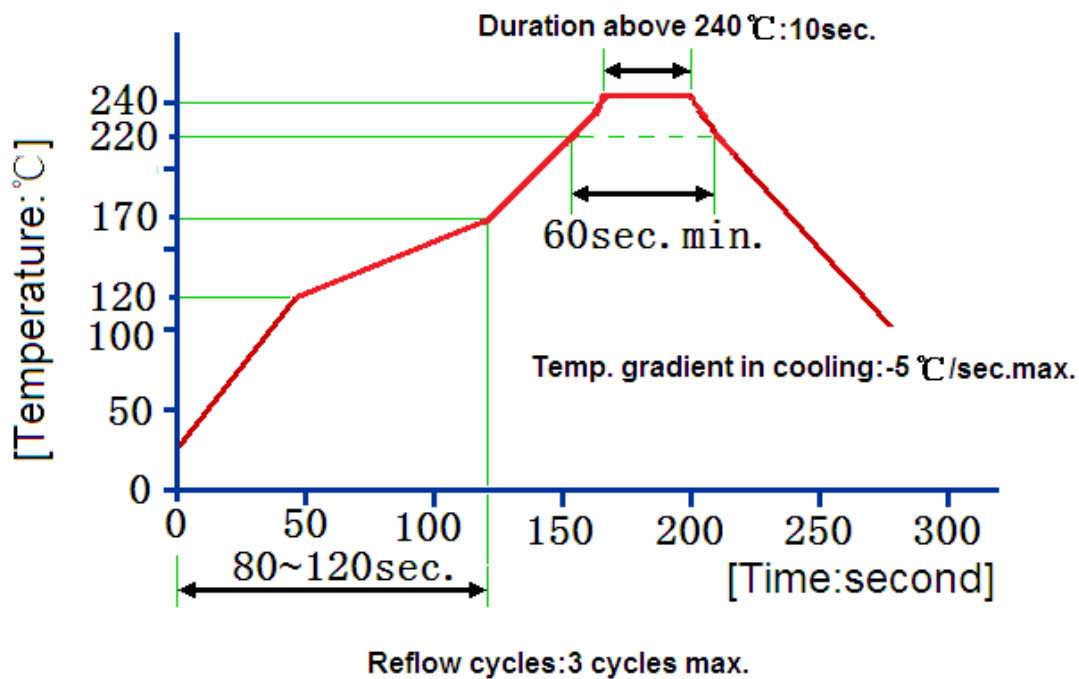

**Notes**

1. As a result of the particularity of inner structure of SAW products, it easy to be breakdown by electrostatic, so we should pay attention to **ESD protect** in the test.
2. **Static voltage** between signal load and ground may cause deterioration and destruction of the component. Please avoid static voltage.
3. **Ultrasonic cleaning** may cause deterioration and destruction of the component. Please avoid ultrasonic cleaning.
4. Only leads of component may **be soldered**. Please avoid soldering another part of component.
5. There is a close relationship between the device's performance and **matching network**. The specifications of this device are based on the test circuit shown above. L and C values may change depending on board layout. Values shown are intended as a guide only.