



APPROVAL SHEET

Approval Specification	Customer's Approval Certificate
TO: Part No.: Customer's Part No.:	Please return this copy as a certification of your approval Checked & Approved by: Date:

BEIJING ZHONGXUN SIFANG SCIENCE & TECHNOLOGY CO.,LTD.

Tel: +86-010-58937383
 Fax: +86-010-58937263
 E-mail: bjzxsf@bjzxsf.net
 Website: <http://www.bjzxsf.net>
 Add: No 201, Block A. Building 3. Yongjie Beilu
 Yongfeng high-tech industrial base
 Haidian District Beijing city



Part No.	:	SF4195
Pages	:	6
Date	:	2013/5/16
Revision	:	1.1

Prepared by:	郑宝琴
Checked by:	卢翠
Approved by:	张德仁

Application

- Low-loss SAW component
- Low amplitude ripple
- Sharp rejections at both out-bands
- Usable passband 8.5 MHz

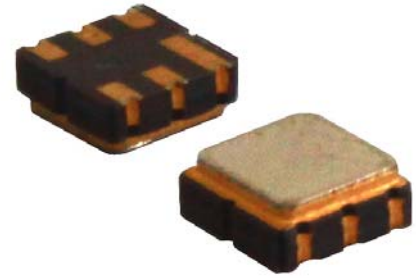

Features

- Ceramic Package for **Surface Mounted Technology (SMT)**
- **RoHS** compatible
- Package size 3.80x3.80x1.50mm³
- Package Code DCC6
- **Electrostatic Sensitive Device(ESD)**

Package Dimensions (Unit: mm)

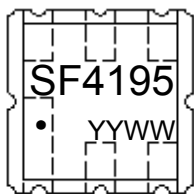
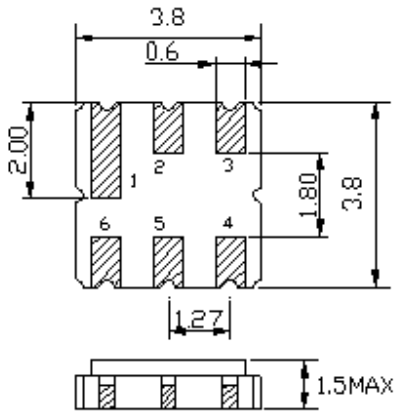

Pin Configuration

Pin No.	Description
2	Input
5	Output
1,3,4,6	Ground

Marking Description

S	Trademark
F	SAW Filter
4195	Part Number
●	Pin 1
YYWW	Year Code & Week Code

*Fig: If the products produced in 06th week of 2012, The year code & week code is 1206.

Test Circuit

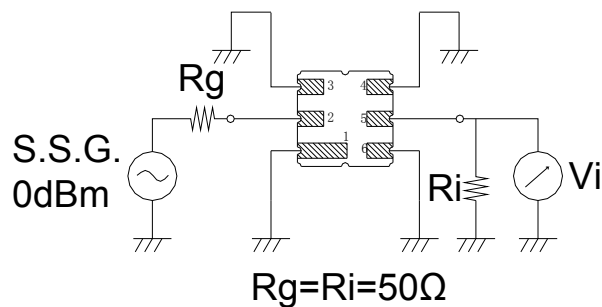

Performance**Maximum Rating**

Item		Value	Unit
DC Voltage	V_{DC}	3	V
Operation Temperature	T	-55 ~ +85	°C
Storage Temperature	T_{stg}	-55 ~ +125	°C
RF Power Dissipation	P	10	dBm

Electronic Characteristics

Test Temperature: $25^{\circ}\text{C} \pm 2^{\circ}\text{C}$

Terminating source impedance: 50Ω

Terminating load impedance: 50Ω

Item		Minimum	Typical	Maximum	Unit
Center Frequency	fc		476.0		MHz
Amplitude Ripple (p-p) ($25^{\circ}\text{C} \pm 2^{\circ}\text{C}$) 471.90-480.40MHz	IL		0.7	1.0	dB
Amplitude Ripple (p-p) ($-55^{\circ}\text{C} \sim +85^{\circ}\text{C}$) 473.00-479.00MHz	IL		0.7	1.0	dB
Insertion Loss 471.90-480.40MHz			2.1	3.0	dB
Absolute Attenuation	α				
	DC-454.00 MHz	40.0	45.0		dB
	498.00-1000.00 MHz	40.0	42.0		dB

Frequency Characteristics

Frequency Response

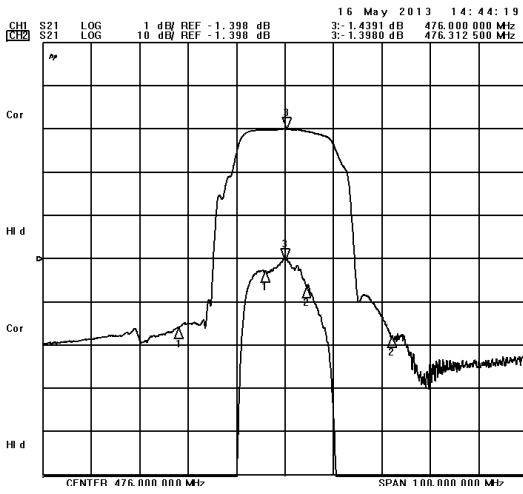

Frequency Response (wideband)

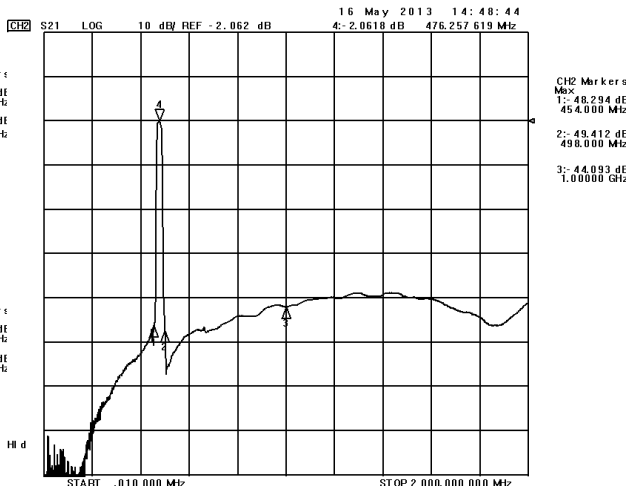

Delay Ripple & S11 VSWR

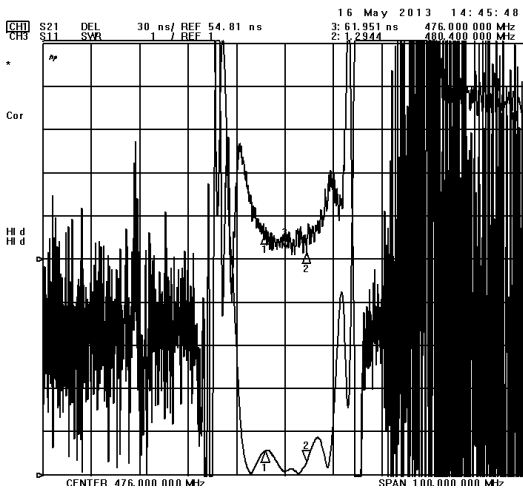

Phase Linearity & S22 VSWR

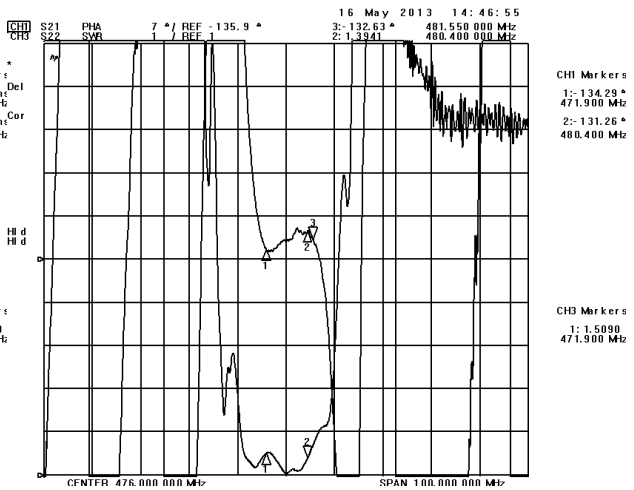

S11 Smith Chart

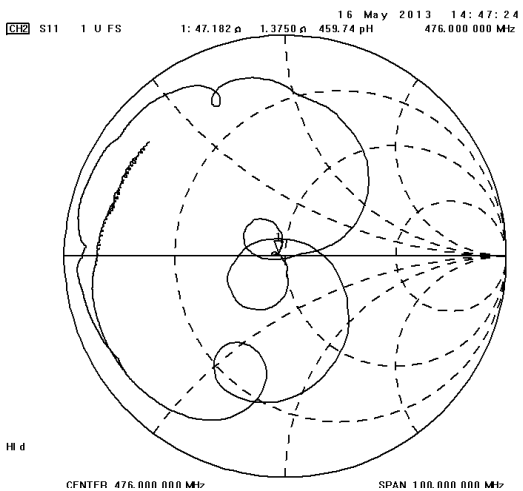

S22 Smith Chart

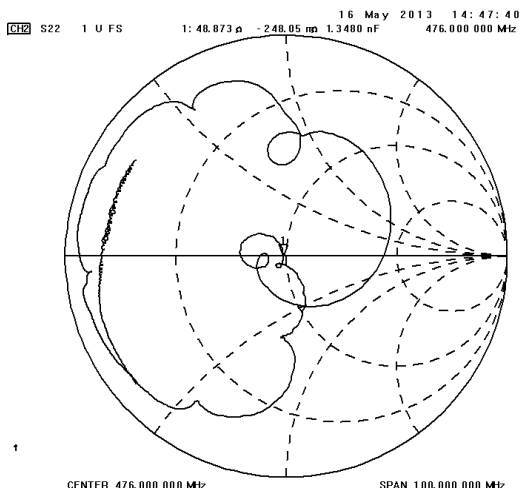

Reliability (The SAW components shall remain electrical performance after tests)

No.	Test item	Test condition
1	Temperature Storage	(1) Temperature: 85°C±2°C , Duration: 250h , Recovery time: 2h±0.5h (2) Temperature: -55°C±3°C , Duration: 250h ,Recovery time: 2h±0.5h
2	Humidity Test	Conditions: 60°C±2°C , 90~95% RH Duration: 250h
3	Thermal Shock	Heat cycle conditions: TA=-55°C±3°C, TB=85°C±2°C, t1=t2=30min, Switch time: ≤3min, Cycle time: 100 times, Recovery time: 2h±0.5h.
4	Vibration Fatigue	Frequency of vibration: 10~55Hz Amplitude:1.5mm Directions: X,Y and Z Duration: 2h
5	Drop Test	Cycle time: 10 times Height: 1.0m
6	Solder Ability Test	Temperature: 245°C±5°C Duration: 3.0s--5.0s Depth: DIP--2/3 , SMD--1/5
7	Resistance to Soldering Heat	(1)Thickness of PCB:1mm , Solder condition: 260°C±5°C , Duration: 10±1s (2)Temperature of Soldering Iron: 350°C±10°C , Duration: 3~4s , Recovery time : 2 ± 0.5h

Recommended Reflow Soldering Diagram

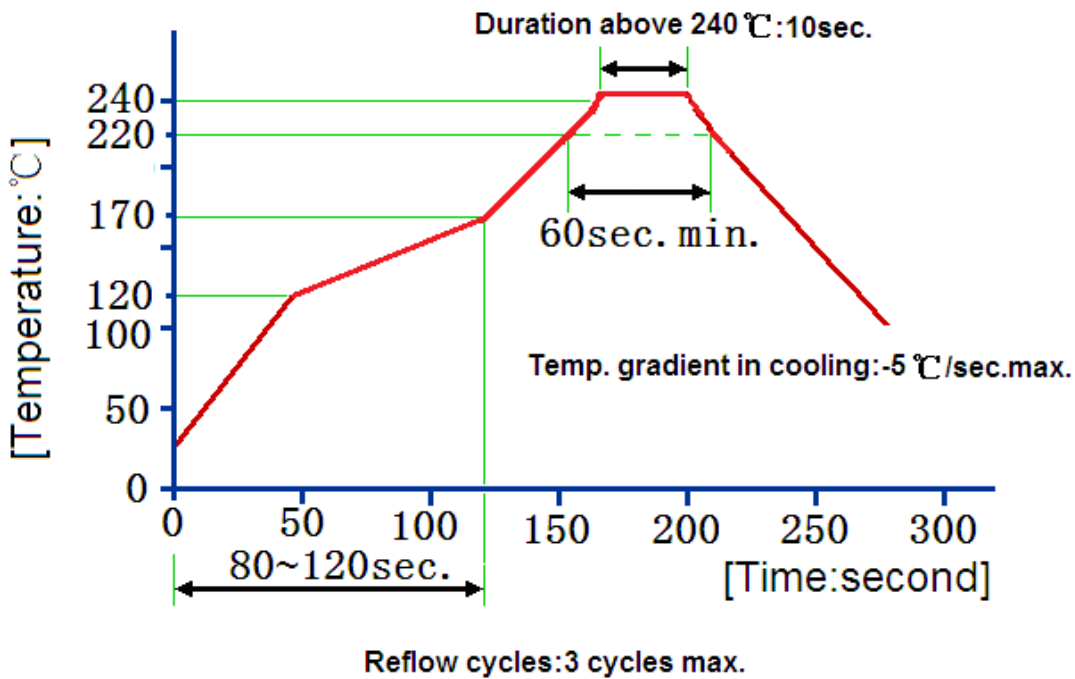

Packing Information

Carrier Tape

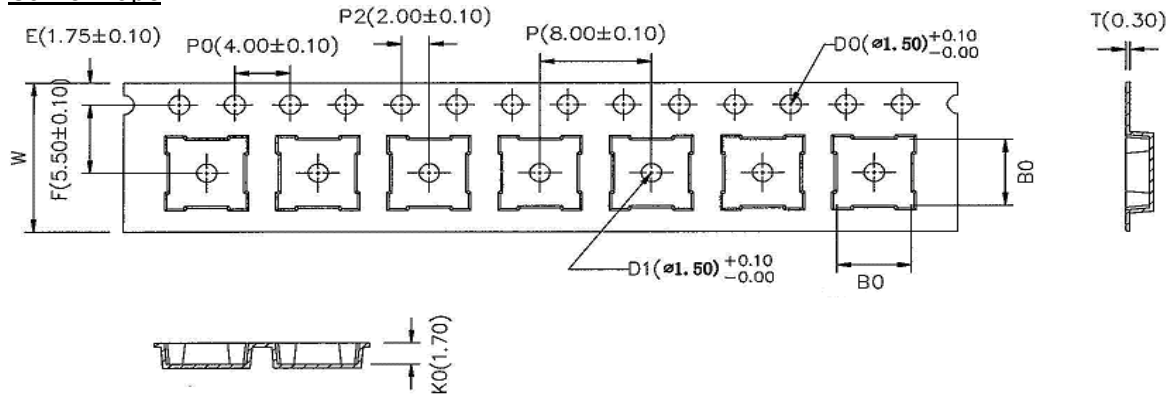

* B0: 5.35 for QCC8C; 4.15 for DCC6/QCC8B; 3.35 for DCC6C/QCC8D

Reel Dimensions



Outer Packing

Type	Quantity	Dimension	Description	Weight
Internal box	1000	190×188×42	carton box	0.18
External box	10000	235×205×210	2 reel / internal box 5 boxes / external box	1.80

Unit: mm

Unit: kg

Notes

1. As a result of the particularity of inner structure of SAW products, it easy to be breakdown by electrostatic, so we should pay attention to **ESD protect** in the test.
2. **Static voltage** between signal load and ground may cause deterioration and destruction of the component. Please avoid static voltage.
3. **Ultrasonic cleaning** may cause deterioration and destruction of the component. Please avoid ultrasonic cleaning.
4. Only leads of component may **be soldered**. Please avoid soldering another part of component.
5. There is a close relationship between the device's performance and **matching network**. The specifications of this device are based on the test circuit shown above. L and C values may change depending on board layout. Values shown are intended as a guide only.