



# APPROVAL SHEET

Approval Specification	Customer's Approval Certificate
<b>TO:</b>	Please return this copy as a certification of your approval
<b>Part No.:</b>	<b>Checked &amp; Approved by:</b>
<b>Customer's Part No.:</b>	<b>Date:</b>

## BEIJING ZHONGXUN SIFANG SCIENCE & TECHNOLOGY CO.,LTD.

Tel: +86-010-58937383  
Fax: +86-010-58937263  
E-mail: [bjzxsf@bjzxsf.net](mailto:bjzxsf@bjzxsf.net)  
Website: <http://www.bjzxsf.net>  
Add: No 201, Block A. Building 3. Yongjie Beilu  
Yongfeng high-tech industrial base  
Haidian District Beijing city



Part No.	:	SF1636
Pages	:	6
Date	:	2017/3/18
Revision	:	1.0

<b>Prepared by:</b>	刘菲
<b>Checked by:</b>	卢翠
<b>Approved by:</b>	高亚京

**Application**

- Low -loss SAW component
- Low amplitude ripple
- Sharp rejections at both out-bands
- Usable Passband 2.50~3.10 MHz

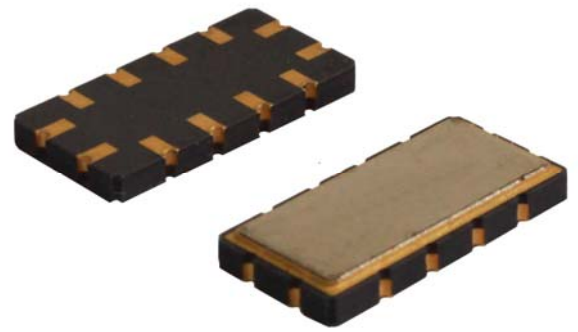

**Features**

- Ceramic Package for **Surface Mounted Technology (SMT)**
- **RoHS** compatible
- Package size 13.30x6.50x1.80mm<sup>3</sup>
- Package Code QCC12
- **Electrostatic Sensitive Device(ESD)**

**Package Dimensions (Unit: mm)**

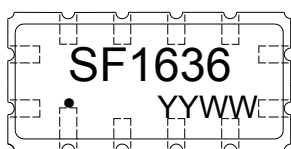
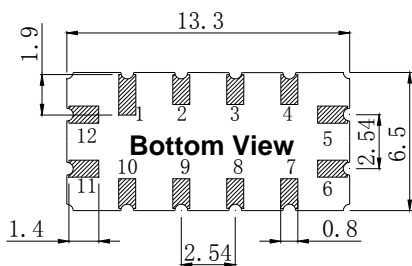

**Pin Configuration**

Pin No.	Description
11	Input
5	Output
1,2,3,4,6,7,8,9,10,12	Ground

**Marking Description**

<b>S</b>	Trademark
<b>F</b>	SAW Filter
<b>1636</b>	Part Number
●	Pin 1
<b>YYWW</b>	Year Code & Week Code

\*Fig: If the products produced in 06<sup>th</sup> week of 2012, The year code & week code is 1206.

**Test Circuit(Bottom View)**

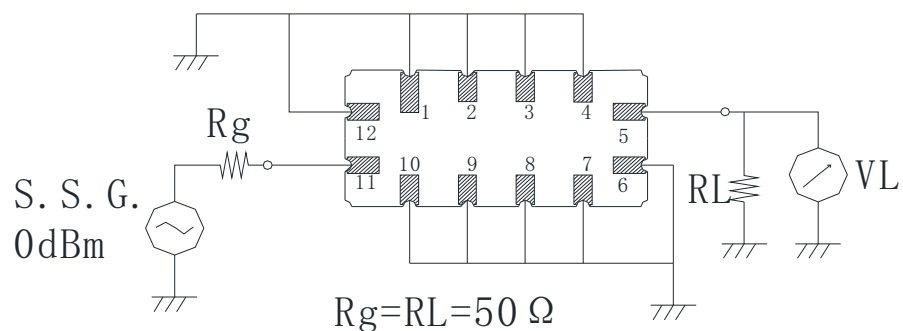

**Performance****Maximum Rating**

Item		Value	Unit
DC Voltage	$V_{DC}$	3	V
Operation Temperature	T	-45 ~ +85	°C
Storage Temperature	$T_{stg}$	-55 ~ +85	°C
RF Power Dissipation	P	10	dBm

**Electronic Characteristics**

Test Temperature:  $25^{\circ}\text{C} \pm 2^{\circ}\text{C}$

Terminating source impedance:  $50\Omega$

Terminating load impedance:  $50\Omega$

Item		Minimum	Typical	Maximum	Unit
Center Frequency	$f_c$		192.0		MHz
Insertion Loss(min)	IL		2.2	4.0	dB
Amplitude Ripple (p-p)	$\Delta a$		0.7	1.0	dB
1.5dB Bandwidth	$BW_{1.5dB}$	2.5	3.05	3.1	MHz
Shape Factor	$\frac{BW_{40dB}}{BW_{3dB}}$		1.5	3.0	/
Absolute Attenuation	$a$				
	172.00MHz	50.0	70.0		dB
	182.00MHz	35.0	70.0		dB
	202.00MHz	35.0	70.0		dB
	212.00MHz	50.0	70.0		dB
Input VSWR			2.2:1	2.5:1	/
Output VSWR			2.2:1	2.5:1	/

Frequency Characteristics

Frequency Response

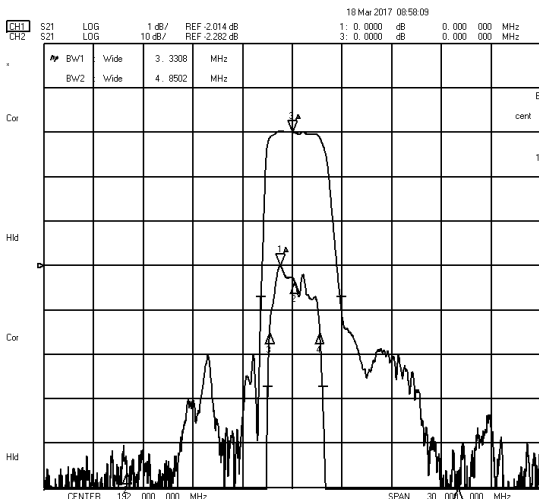

Frequency Response (wideband)

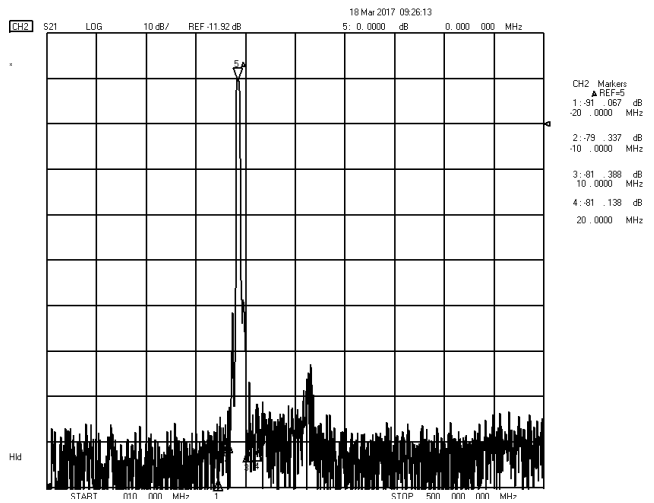

Delay Ripple & S11 VSWR

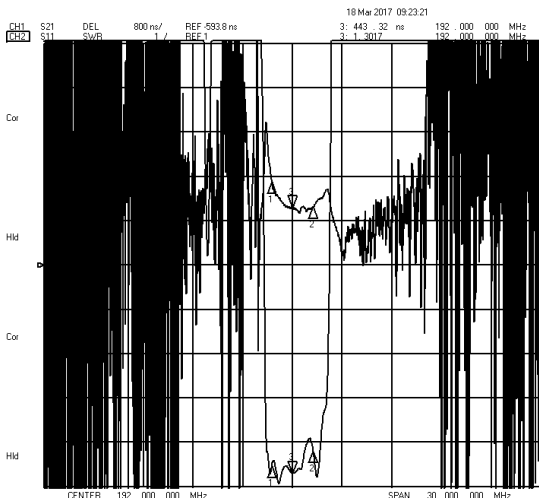

Phase Linearity & S22 VSWR

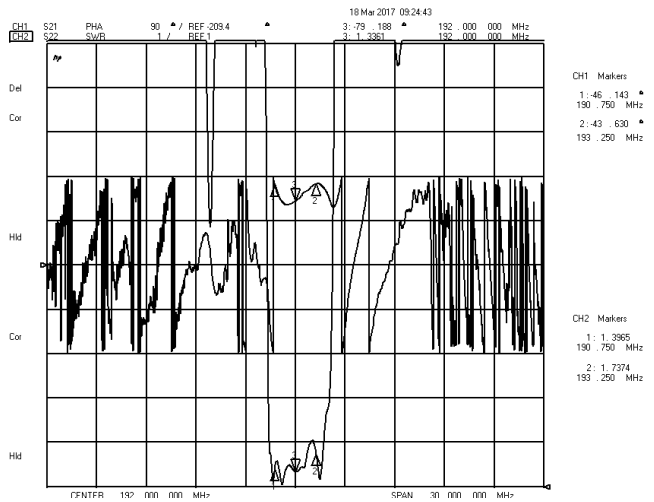

S11 Smith Chart

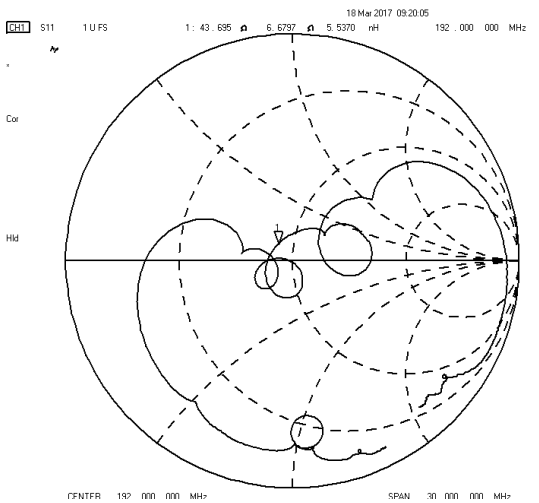

S22 Smith Chart

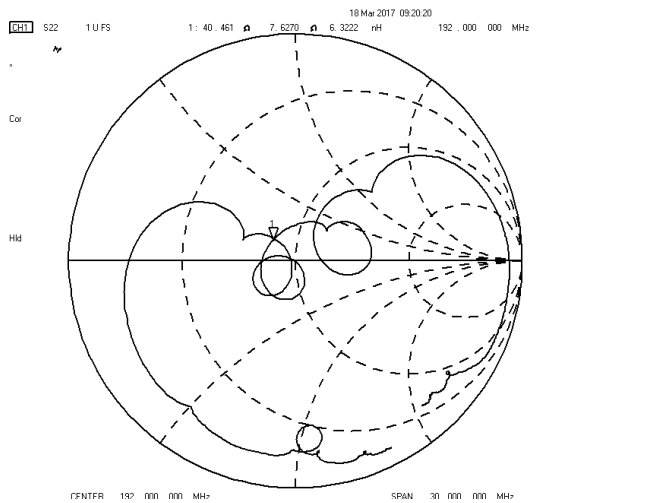

**Reliability (The SAW components shall remain electrical performance after tests)**

No.	Test item	Test condition
1	Temperature Storage	(1) Temperature: 85°C±2°C , Duration: 250h , Recovery time: 2h±0.5h (2) Temperature: -55°C±3°C , Duration: 250h ,Recovery time: 2h±0.5h
2	Humidity Test	Conditions: 60°C±2°C , 90~95% RH                      Duration: 250h
3	Thermal Shock	Heat cycle conditions: TA=-55°C±3°C, TB=85°C±2°C, t1=t2=30min, Switch time: ≤3min, Cycle time: 100 times, Recovery time: 2h±0.5h.
4	Vibration Fatigue	Frequency of vibration: 10~55Hz                      Amplitude:1.5mm Directions: X,Y and Z                                      Duration: 2h
5	Drop Test	Cycle time: 10 times                                      Height: 1.0m
6	Solder Ability Test	Temperature: 245°C±5°C                                  Duration: 3.0s--5.0s Depth: DIP--2/3 , SMD--1/5
7	Resistance to Soldering Heat	(1)Thickness of PCB:1mm , Solder condition: 260°C±5°C , Duration: 10±1s (2)Temperature of Soldering Iron: 350°C±10°C , Duration: 3~4s , Recovery time : 2 ± 0.5h

**Recommended Reflow Soldering Diagram**

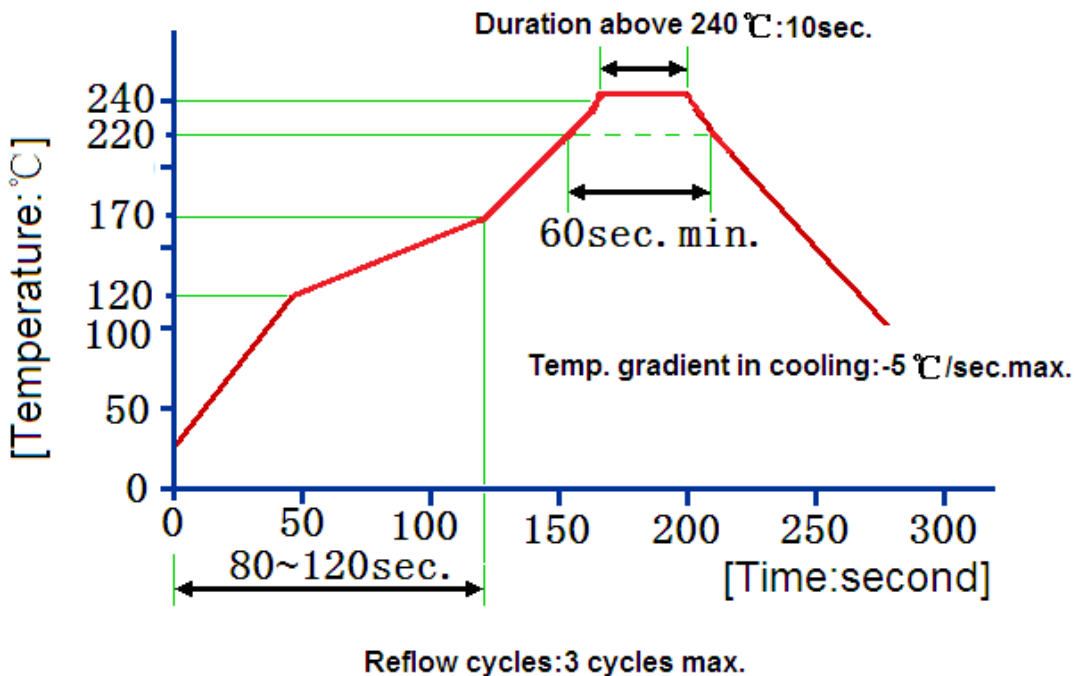

**Notes**

1. As a result of the particularity of inner structure of SAW products, it easy to be breakdown by electrostatic, so we should pay attention to **ESD protect** in the test.
2. **Static voltage** between signal load and ground may cause deterioration and destruction of the component. Please avoid static voltage.
3. **Ultrasonic cleaning** may cause deterioration and destruction of the component. Please avoid ultrasonic cleaning.
4. Only leads of component may **be soldered**. Please avoid soldering another part of component.
5. There is a close relationship between the device's performance and **matching network**. The specifications of this device are based on the test circuit shown above. L and C values may change depending on board layout. Values shown are intended as a guide only.