



APPROVAL SHEET

| Approval Specification | Customer's Approval Certificate |
|-----------------------------|---|
| TO: | Please return this copy as a certification of your approval |
| Part No.: | Checked & Approved by: |
| Customer's Part No.: | Date: |

BEIJING ZHONGXUN SIFANG SCIENCE & TECHNOLOGY CO.,LTD.

Tel: +86-010-58937383
Fax: +86-010-58937263
E-mail: bjzxsf@bjzxsf.net
Website: <http://www.bjzxsf.net>
Add: No 201, Block A. Building 3. Yongjie Beilu
Yongfeng high-tech industrial base
Haidian District Beijing city



| | | |
|----------|---|-----------|
| Part No. | : | SF1641 |
| Pages | : | 6 |
| Date | : | 2017/3/23 |
| Revision | : | 1.0 |

| | |
|---------------------|-----|
| Prepared by: | 刘菲 |
| Checked by: | 卢翠 |
| Approved by: | 高亚京 |

Application

- High-loss SAW component
- Low amplitude ripple
- Sharp rejections at both out-bands
- Usable Passband 27.0 MHz

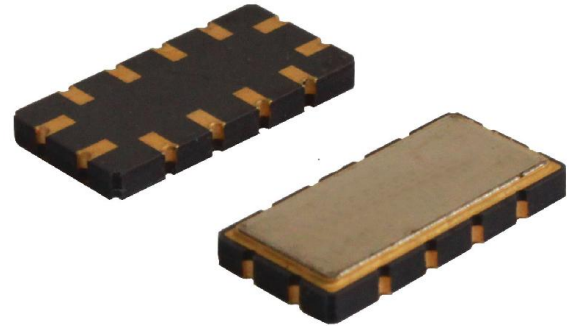

Features

- Ceramic Package for **Surface Mounted Technology (SMT)**
- **RoHS** compatible
- Package size 13.30x6.50x1.80mm³
- Package Code QCC12
- **Electrostatic Sensitive Device(ESD)**

Package Dimensions (Unit: mm)

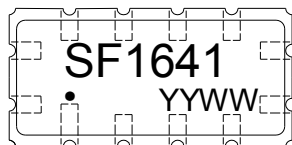
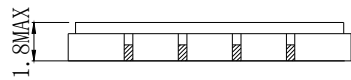
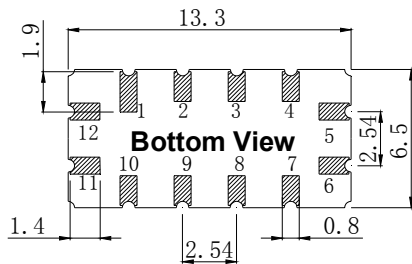

Pin Configuration

| Pin No. | Description |
|-----------------------|-------------|
| 11 | Input |
| 5 | Output |
| 1,2,3,4,6,7,8,9,10,12 | Ground |

Marking Description

| | |
|-------------|-----------------------|
| S | Trademark |
| F | SAW Filter |
| 1641 | Part Number |
| ● | Pin 1 |
| YYWW | Year Code & Week Code |

*Fig: If the products produced in 06th week of 2012, The year code & week code is 1206.

Test Circuit(Bottom View)

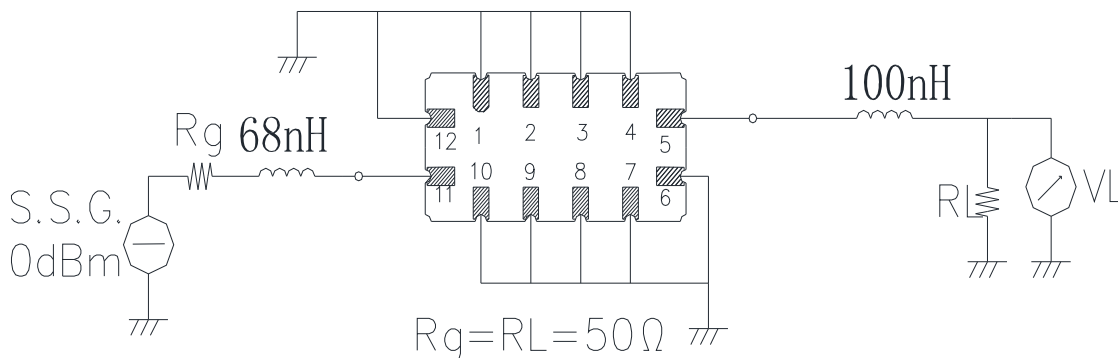

Performance**Maximum Rating**

| Item | | Value | Unit |
|-----------------------|------------------|------------|------|
| DC Voltage | V _{DC} | 3 | V |
| Operation Temperature | T | 25 | °C |
| Storage Temperature | T _{stg} | -55 ~ +125 | °C |
| RF Power Dissipation | P | 10 | dBm |

Electronic Characteristics

Test Temperature: 25°C ± 2°C

Terminating source impedance: 50Ω

Terminating load impedance: 50Ω

| Item | | Minimum | Typical | Maximum | Unit |
|------------------------|-------------------|---------|---------|---------|------|
| Center Frequency | f _c | | 155.8 | | MHz |
| Insertion Loss(min) | IL | | 10.0 | 23.0 | dB |
| Amplitude Ripple (p-p) | Δα | | 0.8 | 1.0 | dB |
| 1 dB Bandwidth | BW _{1dB} | 27.0 | 27.6 | | MHz |
| Absolute Delay@F0 | AD | | 0.72 | | us |
| Absolute Attenuation | α | | | | |
| | DC-137.80MHz | 40.0 | 45.0 | | dB |
| | 172.80-187.80MHz | 25.0 | 40.0 | | dB |
| | 191.80-202.80MHz | 40.0 | 50.0 | | dB |
| | 207.80-500.00MHz | 40.0 | 45.0 | | dB |

Frequency Characteristics

Frequency Response

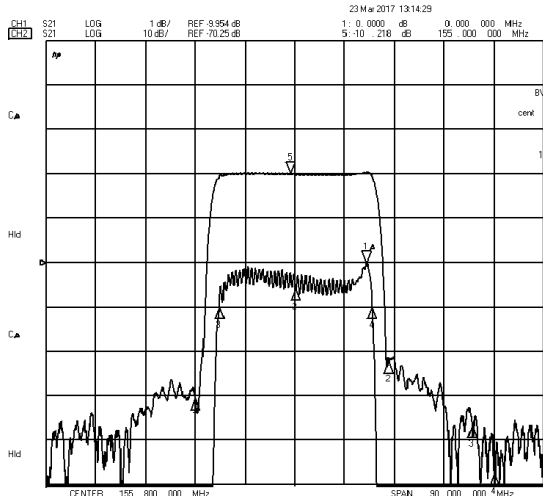

Frequency Response (wideband)

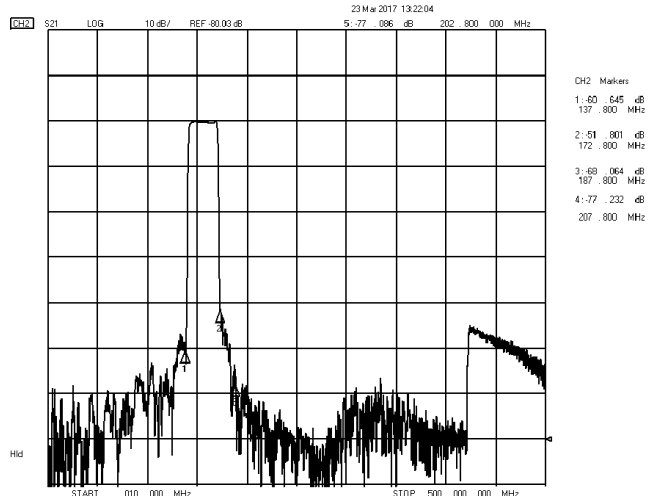

Delay Ripple & S11 VSWR

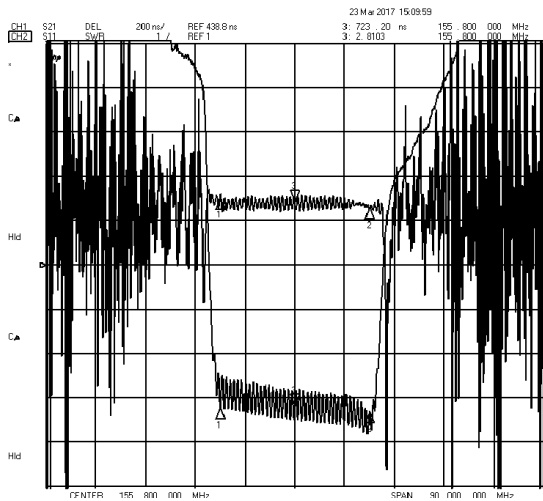

Phase Linearity & S22 VSWR

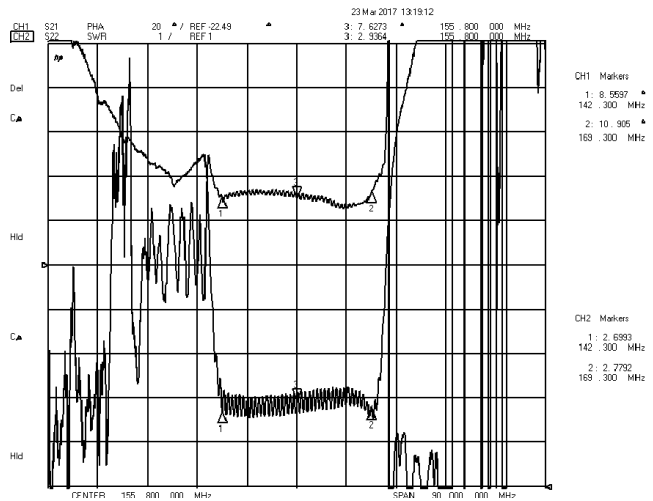

S11 Smith Chart

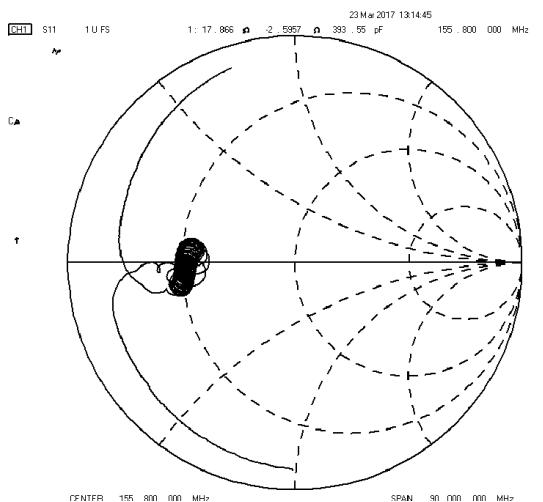

S22 Smith Chart

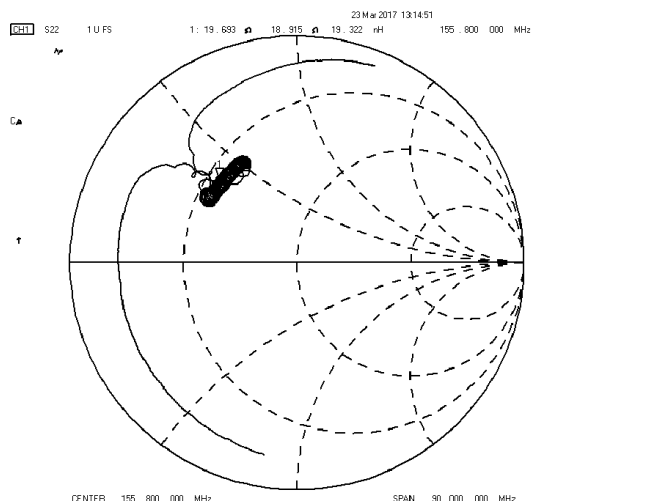

Notes

1. As a result of the particularity of inner structure of SAW products, it easy to be breakdown by electrostatic, so we should pay attention to **ESD protect** in the test.
2. **Static voltage** between signal load and ground may cause deterioration and destruction of the component. Please avoid static voltage.
3. **Ultrasonic cleaning** may cause deterioration and destruction of the component. Please avoid ultrasonic cleaning.
4. Only leads of component may **be soldered**. Please avoid soldering another part of component.
5. There is a close relationship between the device's performance and **matching network**. The specifications of this device are based on the test circuit shown above. L and C values may change depending on board layout. Values shown are intended as a guide only.