



APPROVAL SHEET

Approval Specification	Customer's Approval Certificate
TO:	Please return this copy as a certification of your approval
Part No.:	Checked & Approved by:
Customer's Part No.:	Date:

BEIJING ZHONGXUN SIFANG SCIENCE & TECHNOLOGY CO.,LTD.

Tel: +86-010-58937383
Fax: +86-010-58937263
E-mail: zxsf_sales@163.com
QQ: 2109300457
Website: <http://www.bjzxsf.net>
Add: No 201, Block A. Building 3. Yongjie Beilu
Yongfeng high-tech industrial base
Haidian District Beijing city



Part No.	:	SF8146
Pages	:	6
Date	:	2017/2/20
Revision	:	1.0

Prepared by:	
Checked by:	
Approved by:	

Application

- Low-loss SAW component
- Low amplitude ripple
- Sharp rejections at both out-bands
- Usable passband 25.1 MHz

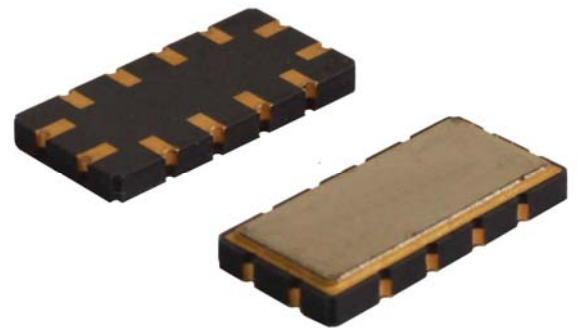

Features

- Ceramic Package for **Surface Mounted Technology (SMT)**
- **RoHS** compatible
- Package size 13.30x6.50x1.80mm³
- Package Code QCC12
- **Electrostatic Sensitive Device(ESD)**

Package Dimensions (Unit: mm)

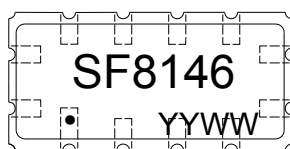
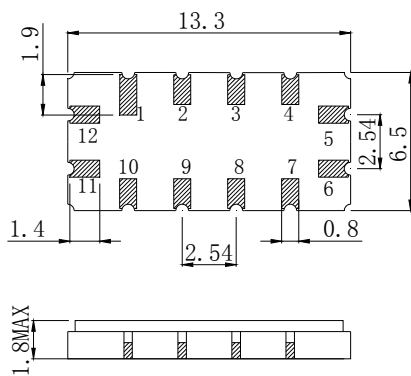

Pin Configuration

Pin No.	Description
11	Input
5	Output
1,2,3,4,7,8,9,10	Case Ground
6,12	To be Grounded

Marking Description

SF	SF	Trademark
	F	SAW Filter
8146	Part Number	
●	Pin 1	
YYWW	Year Code & Week Code	

*Fig: If the products produced in 06th week of 2015, The year code & week code is 1506.

Test Circuit (Bottom View)

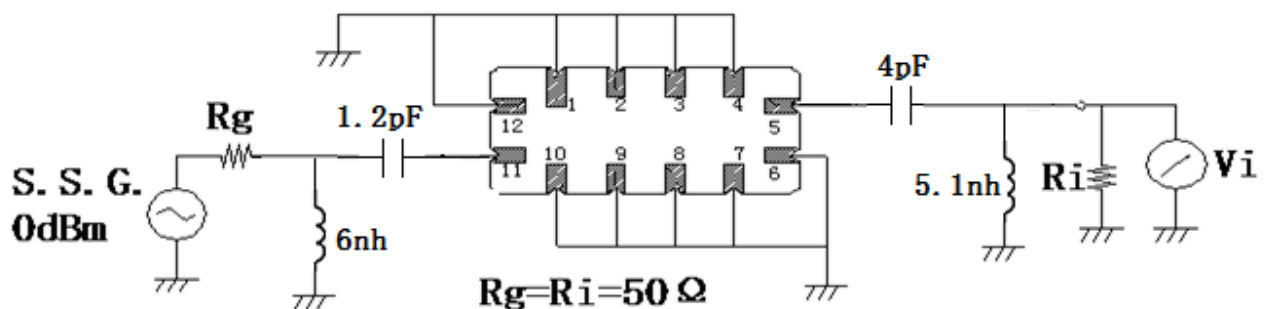

Performance**Maximum Rating**

Item		Value	Unit
DC Voltage	V_{DC}	3	V
Operation Temperature	T	-40 ~ +85	°C
Storage Temperature	T_{stg}	-55 ~ +125	°C
RF Power Dissipation	P	15	dBm

Electronic Characteristics

Test Temperature: $25^{\circ}\text{C} \pm 2^{\circ}\text{C}$

Terminating source impedance: 50Ω

Terminating load impedance: 50Ω

Item		Minimum	Typical	Maximum	Unit
Center Frequency	f_c		881.5		MHz
Insertion Loss(min)	IL		28.9	30.0	dB
1 dB Bandwidth	@881.5 MHz BW_{1dB}	25.1	26.0		MHz
3 dB Bandwidth	@881.5 MHz BW_{3dB}	25.5	26.6		MHz
40 dB Bandwidth	@881.5 MHz BW_{40dB}		29.7	30.5	MHz
Amplitude Ripple (p-p)	Δa		1.0		dB
Absolute Group Delay	@881.5 MHz AD		0.97		μs
Absolute Attenuation	a				
	500.00 – 866.00 MHz	35.0	38.0		dB
	897.00 – 1002.00 MHz	35.0	37.0		dB

Frequency Characteristics

Frequency Response

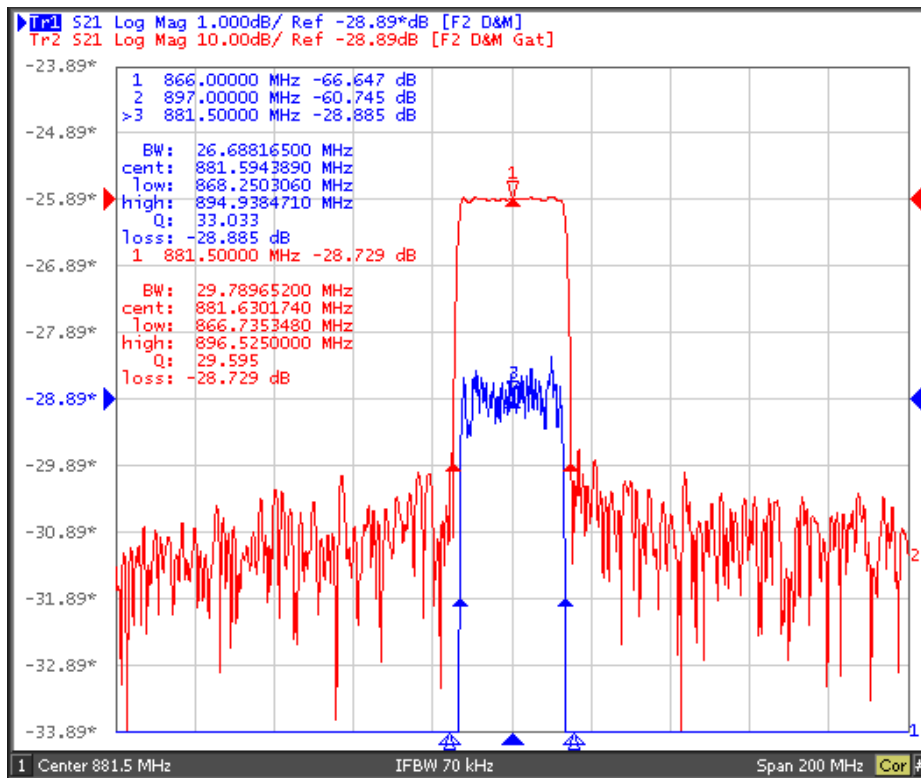

Frequency Response (wideband)

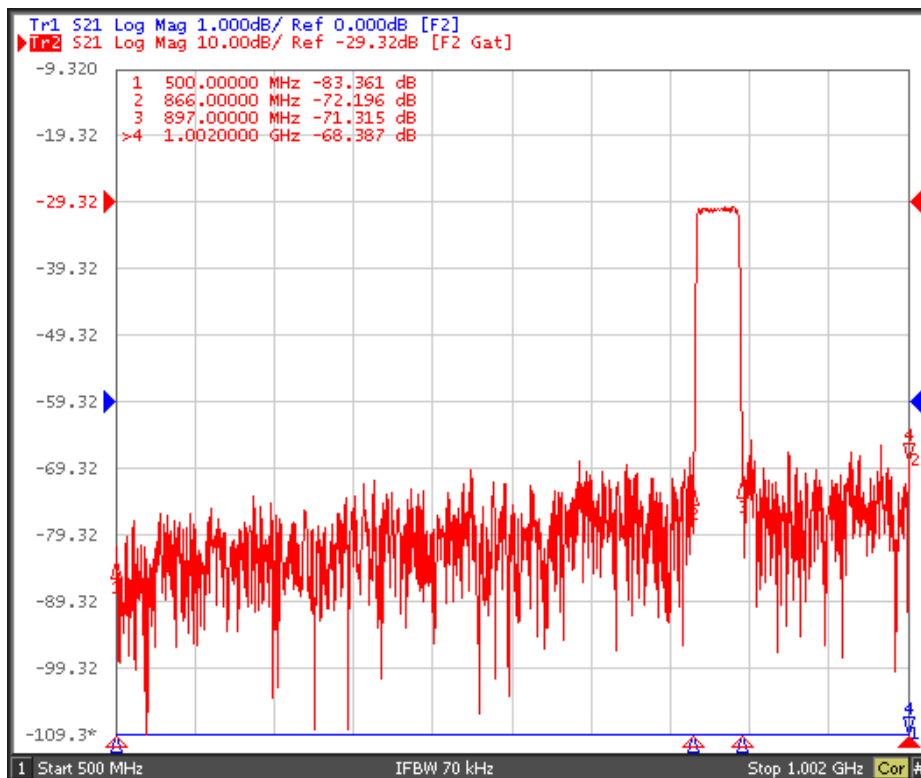

Notes

1. As a result of the particularity of inner structure of SAW products, it easy to be breakdown by electrostatic, so we should pay attention to **ESD protect** in the test.
2. **Static voltage** between signal load and ground may cause deterioration and destruction of the component. Please avoid static voltage.
3. **Ultrasonic cleaning** may cause deterioration and destruction of the component. Please avoid ultrasonic cleaning.
4. Only leads of component may **be soldered**. Please avoid soldering another part of component.
5. There is a close relationship between the device's performance and **matching network**. The specifications of this device are based on the test circuit shown above. L and C values may change depending on board layout. Values shown are intended as a guide only.